

**LAVABICCHIERI PROFESSIONALI
PROFESSIONAL GLASSWASHERS
LAVE-VERRES PROFESSIONNELS
PROFESSIONELLER GLÄSERSPÜLER
LAVAVASOS PROFESIONAL
MÁQUINAS DE LAVAR COPOS PROFISSIONAL**

**CW350B CW350BS CW350BSD
CW350 CW350S CW350SD
CW400B CW400BS CW400BSD
CW400R CW400RS CW400RSD**



- 1 Safety and usage instructions**
- 2 Technical characteristics**
- 3 Installation and positioning**
- 4 Installer – technical assistant instructions**
- 5 First startup**
- 6 Settings**
- 7 Screen-displayed anomalies (technical)**
- 8 User instructions Mod. CW400R – CW400RSD**

- 9 User Instructions Mod. CW350B-CW350BSD-CW350-CW350SD-CW400B-CW400BSD**
- 10 Maintenance and cleaning**
- 11 Problems and anomalies (user)**
- 12 Screen-displayed anomalies (user)**
- 13 Electrical - Connections scheme**

Thank you for having chosen this product.

We recommend that you read all of the instructions contained in the manual attentively in order to become familiar with the most suitable conditions for the correct use of the dishwasher.

TECHNICAL INSTRUCTIONS:



Are intended for qualified personnel who will perform the installation, the setup, the testing and eventual assistance operations.

USER INSTRUCTIONS:



Indicate the recommended usage, the command descriptions and the proper cleaning and maintenance operations for the dishwasher.

1 Safety and usage instructions



THIS MANUAL CONSTITUTES AN INTEGRAL PART OF THE DISHWASHER; IT MUST NECESSARILY BE STORED INTEGRAL AND TOGETHER WITH THE APPARATUS.



THE POSITIONING, CONNECTIONS, SETUP AND TROUBLESHOOTING, AND THE SUBSTITUTION OF THE POWER CABLE MUST **BE PERFORMED BY QUALIFIED PERSONNEL.**

THE DISHWASHER IS INTENDED EXCLUSIVELY FOR PROFESSIONAL USE AND MUST BE USED BY COMPETENT PERSONNEL. IT IS DESIGNED TO WASH DISHES (PLATES, CUPS, BOWLS, BAKING PANS, SILVERWARE) AND SIMILAR ITEMS FROM THE GASTRONOMY AND THE COLLECTIVE RESTAURANT INDUSTRIES. IT CONFORMS TO THE INTERNATIONAL ELECTRIC AND MECHANICAL SAFETY NORMS (**CEI-EN-IEC 60335-2-58/61770**) AND ELECTROMAGNETIC COMPATIBILITY NORMS (**CEI-IEC-EN 55014-1/-2, 61000-3;4, 50366**).

THE MANUFACTURER **DECLINES ANY RESPONSABILITY** FOR DAMAGE TO PERSONS OR THINGS CAUSED **BY NON-OBSERVANCE** OF THE INSTRUCTIONS PRESENT IN THE MANUAL, BY **INCORRECT USE**, BY **TAMPERING** EVEN WITH A SINGLE PART OF THE APPARATUS AND BY USE OF **NON-ORIGINAL REPLACEMENT PARTS.**



THE **ELECTRICAL GROUNDING** OF THE APPARATUS ACCORDING TO THE METHODS PRESCRIBED BY THE ELECTRICAL SYSTEM'S SAFETY NORMS **IS OBLIGATORY.**

THIS APPARATUS IS MARKED IN CONFORMITY TO THE EUROPEAN DIRECTIVE **2002/96/EC**, WASTE ELECTRICAL AND ELECTRONIC EQUIPMENT (WEE). BY ENSURING THAT THIS PRODUCT BE DISPOSED OF IN A CORRECT MANNER, THE USER CONTRIBUTES TO THE PREVENTION OF POTENTIALLY NEGATIVE ENVIRONMENTAL AND HEALTH CONSEQUENCES.

THE  SYMBOL ON THE PRODUCT, OR UPON ITS ACCOMPANYING DOCUMENTATION, INDICATES THAT THIS PRODUCT MUST NOT BE TREATED AS DOMESTIC WASTE, BUT MUST BE TAKEN TO A SUITABLE COLLECTION DEPOT FOR THE RECYCLING OF ELECTRIC AND ELECTRONIC APPARATUS. DISPOSE OF THE APPARATUS ACCORDING TO THE LOCAL WASTE DISPOSAL NORMS. FOR MORE INFORMATION ON THE TREATMENT, RECOVERY AND RECYCLING OF THIS PRODUCT, CONTACT YOUR COMPETENT LOCAL AUTHORITY, YOUR DOMESTIC WASTE DISPOSAL SERVICE OR THE STORE IN WHICH THE PRODUCT WAS PURCHASED.



DO NOT INSERT SOLVENTS SUCH AS ALCOHOL OR TURPENTINE WHICH COULD PROVOKE EXPLOSIONS. DO NOT INSERT DISHES WITH RESIDUES OF ASH, WAX OR VARNISH.



NEVER USE THE DISHWASHER OR ITS PARTS AS A STEP-LADDER, SUPPORT OR BRACE FOR PERSONS, THINGS OR ANIMALS. LEANING OR SITTING UPON THE DISHWASHER'S OPEN DOOR COULD CAUSE IT TO TIP, WITH CONSEQUENT PERSONAL DANGER. DO NOT LEAVE THE DISHWASHER'S DOOR OPEN IN ORDER TO AVOID TRIPPING UPON IT.



DO NOT DRINK THE RESIDUAL WATER EVENTUALLY PRESENT IN THE DISHES OR IN THE DISHWASHER AFTER A WASH CYCLE.



THE APPARATUS IS NOT ADAPTED FOR USE BY MINORS AND PEOPLE WITH REDUCED PHYSICAL, SENSORIAL OR MENTAL CAPABILITIES WITHOUT EXPERIENCE OR FAMILIARITY WITH THE DEVICE. THE USE OF THE APPARATUS IS PERMITTED TO THESE PEOPLE ONLY UNDER THE SUPERVISION OF A PERSON IN CHARGE OF THEIR SAFETY.

2 Technical characteristics

TECHNICAL CHARACTERISTICS					
		CW350B CW350BS CW350BSD	CW350 CW350S CW350SD	CW400B CW400BS CW400BSD	CW400R CW400RS CW400RSD
Input voltage power	V	230V/1	230V/1	230V/1	400V 3N ~
Frequency	Hz	50	50	50	50
Max. absorbed power	kW	2,9	2,9	2,9	4,8
Boiler resistance power	kW	2,6	2,6	2,6	4,5
Tank resistance power	kW	1,6	1,6	1,6	1,6
Wash pump power	kW	0,3	0,3	0,3	0,3
Water supply pressure	kPa (bar)	200-400 (2 ÷ 4)	200-400 (2 ÷ 4)	200-400 (2 ÷ 4)	200-400 (2 ÷ 4)
Water supply temperature	°C	50°C – 60°C	50°C – 60°C	50°C – 60°C	50°C – 60°C
“S” versions Water supply temperature (incorporated water-softener)	°C	15°C – 30°C	15°C – 30°C	15°C – 30°C	15°C – 30°C
Water supply hardness	°dF	7°dF-12°dF	7°dF-12°dF	7°dF-12°dF	7°dF-12°dF
Rinse cycle water consumption	l	2,4	2,4	2,4	3,5
Boiler capacity	l	2,7	2,7	3,9	5,5
Tank capacity	l	10	10	14	35
Standard cycle duration with water supply at 50°C	s	120/180	120/180	120/180	60/120/180/C
Noise level	dB(A)	56	56	56	56
Protection rating	IPX	4	4	4	4
Net weight	kg	31	37	44	53
Power cable type	◀HAR▶	H05VV-F	H05VV-F	H05VV-F	H07RN-F

NOTE: “D” = versions with integrated detergent metering unit – “S” versions with integrated water-softener

3 Installation and positioning

INSTALLATION and POSITIONING

Bring the dishwasher to its installation location, remove its packaging and verify the integrity of the apparatus and of the components. If damaged, written notification must be sent to the transporter.

The packaging elements (plastic bags, polystyrene foam, nails, etc) must not be left within reach of children and domestic animals as they are a potential source of danger.

All of the materials used for packaging are compatible with the environment. They may be safely preserved, or may be disposed of at an appropriate waste disposal facility.

The components in plastic material subject to eventual disposal through recycling are marked in the following manner:

PE polyethylene: external wrapping, instructions bag, protection bags.

PP polypropylene: bands.

PS polystyrene foam: protective corners, packaging cover.

The wood and cardboard components can be disposed of by respecting the norms in vigor.
When disposing of the product, avoid leaving it in the environment; its disposal must respect the norms in vigor.
All of the metallic parts are in stainless steel and are detachable.
The plastic parts are marked with the symbol of the relative material.

POSITIONING:



Warning: the internal system and the locations in which communal apparatus are to be installed, must answer to the norms in vigor.

The manufacturer declines any responsibility for direct damages to persons or things deriving from lack of respect for the said norms.

Prior to installation verify that objects and materials which could be damaged by aqueous vapor or by spray from washing solutions are not in the vicinity, or are adequately protected.

Position the dishwasher in the desired position and remove the protective wrapping.

Level the dishwasher (with the help of a level) on its four feet, regulating them in such a way so as to guarantee stability; any alternate solution must be approved by the manufacturer.

4 INSTALLER – TECHNICAL ASSISTANT INSTRUCTIONS

Water and drain connection:

The water tubes and the electrical power cable stick out from the back of the machine. Connect the water supply tube to a 3/4" threaded **gas** outlet.

Use only new tubes for the connection to the water supply; old or used tubes must not be utilized.

The dynamic **supply pressure** must be between **2 and 4 bar**; if the pressure is higher, a pressure reducer must be installed.

It is indispensable to install a general faucet on the supply water input tubing; the faucet must be accessible after installation has been completed. Do not install the faucet behind the dishwasher.

The declared cycle durations refer to a **50° hot water supply**.

Where a cold water supply is used, the duration of the cycle could increase in relation to the input water temperature since the dishwasher is equipped with a constant temperature and pressure rinse system.

Drain:

Every dishwasher comes equipped with a drain connection tube; this is prescribed to be at floor level, with a trap drain.



Caution: make sure that the supply and drain tubes are not bent, restricted or crushed after installation.



4.1 Electrical connection

The dishwasher's electrical connection and that of eventual supplementary apparatus is to be entrusted to authorized and qualified personnel, with respect to the norms in vigor; observe also the technical regulations for the connections.

The total power installed is given upon the apparatus' technical data label.

Other apparatus must not be protected along with the dishwasher.

The user must provide for the installation, according to the norms in vigor, of a main electrical power switch and of a differential switch compatible with the machine's characteristics.

These switches must be installed near the dishwasher, be easily accessible after installation and guarantee complete disconnection from the electrical supply in category III overvoltage conditions.



Caution!!!

The dishwasher is free of electrical current only when the main switch is off.

- Connect the apparatus to the usage equalizer. The  clamp for the connection is located at the lower

back of the machine.

- The protection conductor (PE) is yellow-green in color, the neutral conductor (N) is blue and the phase conductors (L1, L2, L3) are black, gray and brown.

5 FIRST STARTUP

FIRST STARTUP

The electrical protection system must be subjected to a functional test before use. The installation must be performed and/or verified by the authorized reseller who will be responsible for the first startup and the instructions relative to the dishwasher's operation.

PREPARATION FOR USE

Important:

The rinse-aid metering unit comes equipped in all models while the detergent metering unit comes equipped in only some models.

If both metering units are present position the external detergent and rinse-aid containers and insert their respective suction tubes located at the back of the machine.

Red tube: detergent

Transparent tube: rinse-aid

Before inserting the tubes in the containers apply the weight (necessary to keep the tube at the bottom of the container) and the filter as indicated in the diagram.

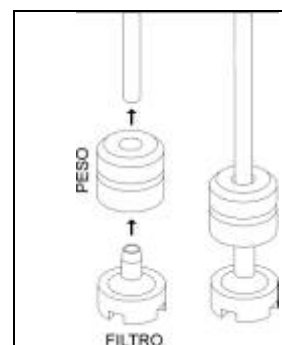
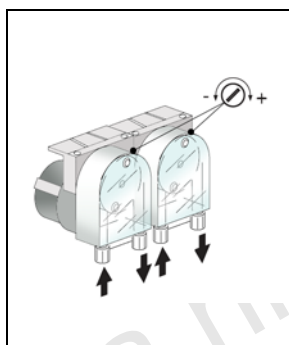

For adjustments, use the adjustment screws indicated in the diagram. It is recommended that adjustments be performed by personnel from the companies who have supplied the detergent products.

If the detergent metering unit did not come pre-installed it can be installed at a later time by ordering the relative KIT.

Alternatively, an external metering unit can be connected by means of an electrical connection with a 2x0.5 mm type H05 RN-F cable. This cable must be inserted through the passage indicated in the TECHNICAL CHARACTERISTICS scheme and connected in accordance with the electrical scheme furnished with the dishwasher.

The metering unit must be of 230V/50Hz with a maximum absorbed power of **15W**.

Connect the detergent metering unit to the dishwasher through the red tube cited above.

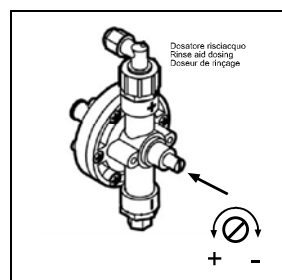

6 SETTINGS (only models CW400RSD - CW400R – CWC500R)



SETTINGS

During the first startup, arrange for the setup or the adjustment of the functions/parameters indicated hereafter:

POWER SUPPLY: 200 – 250 VAC.

ABSORBED POWER : 4 VA

OPERATIONAL TEMPERATURE: 0 / 60 °C

OPERATIONAL HUMIDITY: max 90 % without condensation

NORMS: The control unit is designed and manufactured in observance of the

European norms in vigor regarding electrical safety and electromagnetic compatibility.

Particularly the following:

EN 61000-6-3 : Emissions for residential and commercial environments

EN 61000-6-2 : Immunity for industrial environments

EN 61000-4-11 : Immunity to supply micro-interruptions

EN 60335-1 : Low voltage safety directive

ZERO CROSSING : The relay which powers the Tank's electrical resistance is equipped with the " zero crossing " function which synchronizes the switching of this relay, both in closing and in opening, with the voltage supply's passing to zero both for 50 Hz and 60 Hz frequencies. In this manner the relay's contacts usage is significantly reduced.

CONNECTION SCHEME

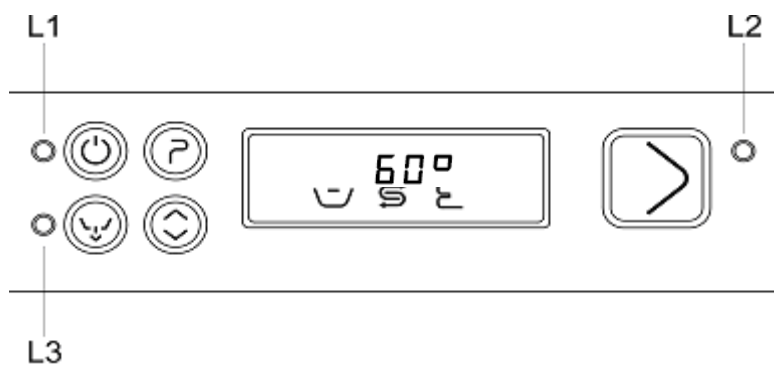

Clamp	Connection for model. CWC500R	Connection for models CW400RSD – CW400R
1 – 2	CONTROL UNIT POWER SUPPLY, 230 VAC	CONTROL UNIT POWER SUPPLY, 230 VAC
3 – 4	BOILER TEMPERATURE SENSOR	BOILER TEMPERATURE SENSOR
5 – 6	TANK TEMPERATURE SENSOR	TANK TEMPERATURE SENSOR
10	BREAK-TANK PRESSOSTAT	BREAK-TANK PRESSOSTAT
11	Reserve input	SALT CONTAINER SENSOR
12	MICRO HOOD	MICRO DOOR
13	TANK PRESSOSTAT, closed over level	TANK PRESSOSTAT, closed over level
14	COMMON INPUTS	COMMON INPUTS
15	BOILER RESISTANCE REMOTE CONTROL SWITCH COIL	BOILER RESISTANCE REMOTE CONTROL SWITCH COIL
16	TANK RESISTANCE, max. 10 Amp.	TANK RESISTANCE, max. 10 Amp.
17	-	REGENERATION ELECTROVALVE
18	-	COLD RINSE ELECTROVALVE
18 B.TANK	RINSE PUMP (MACHINE TYPE 4)	RINSE PUMP (MACHINE TYPE 4)
19	WASH PUMP (max. 1 HP)	WASH PUMP (max. 1 HP)
20	RINSE ELECTROVALVE + PRESSURE INCREASE PUMP	RINSE ELECTROVALVE + PRESSURE INCREASE PUMP
21	DRAIN PUMP (max. 0.75 HP) Optional	DRAIN PUMP (max. 0.75 HP) Optional
22	OUTPUT POWER SUPPLIES, 230 VAC phase	OUTPUT POWER SUPPLIES, 230 VAC phase

KEYBOARD FUNCTIONALITY CW400RSD – CW400R



MAIN FUNCTIONS WITH MACHINE POWERED

ITEM	Description	Function
L1	Machine powered led indicator	This led indicator turns on (green) when electrical current is present
L2	Tank emptying led indicator	This led indicator (green) indicates that the machine is emptying the Tank – the led flashes when the operation is in progress.
	On/Off button	Pressing this button with led indicator 1 on activates the keyboard and renders the machine operational. The last program used (wash cycles) will be shown on the 3 displays when turned on.
	Tank emptying button	To empty the Tank first remove the Tank's overflow, then press the button for 3 seconds. This inhibits water from being loaded and, after a Pressostat Tank-empty signal verifies that the Tank has been emptied, will only allow a limited amount of boiler water to circulate in order to facilitate the cleaning of the Tank. At the end of the function the machine goes into a stand-by phase which is indicated by the appearance of three dashes "---" upon the displays. To render the machine operational again it is therefore necessary to insert the Tank's overflow and to press the button. If the machine is equipped with the drain pump option, the drain pump will also be activated.
	Programs button	By repeatedly pressing this button the various wash cycles can be viewed (brief 60", medium 120", long 180", continuous)
	OPTIONS button	The use of this button does the following, in sequence: <ul style="list-style-type: none"> Enables the "crystal cycle" only with the medium cycle 120" ("C" on the display"); Sets the T of the boiler from 85°C to 70°C Enables regeneration (rig on the display) if decal is installed. (if a program has not been set, it will not be performed)
	Tank led indicator	Indicates, when on, that the temperature shown during washing is that of the Tank.
	Salt led indicator	Indicates insufficient salt quantity (if prescribed in the function) The led indicator turns on for the closing of a reed contact.
	Boiler led indicator	Boiler resistance in function symbol











	3 DISPLAY	Can indicate the program which will begin and the boiler/Tank temperature. In case of anomalies an error code will be indicated, for example "E 1" - Boiler temperature anomaly - Tank temperature anomaly - Tank loading anomaly - Tank draining anomaly - Boiler anomaly
	Start button	Initiates the program shown on the display
L3 	Bicolor led indicator	This led indicates the state of the machine <ul style="list-style-type: none"> • Green indicates the machine is ready for a new program • Red indicates the machine is busy with an operation • Yellow indicates a break after Tank draining

MACHINE CONFIGURATION PARAMETERS (Intended for technical personnel, not the user)

Parameter	Description	Range	Preset
P0	Drain cycle time	1-5'	1
P1	Boiler temperature	60-95°C	82
P2	Tank temperature	40-65°C	55
P3	Rinse duration	10-40"	13
P4	BOILER STOP option	YES/NO	1 YES
P5	Brief wash time	60-90	60
P6	Drain with overflow option	YES/NO	1 YES
P7	Cold rinse option	YES/NO	0 NO
P8	Regeneration option	YES/NO	1 YES
P9	Maximum water load duration	1-10'	10
P10	H2O Hardness (to be set by the user based on water hardness)	35	15
P11	Machine type	4	4
P12	Wash number counter	YES	1 YES

PARAMETER FUNCTION WITH MACHINE ON

Upon first installation it is possible to perform a series of operations which allow for the personalization of the dishwasher based on the user's necessities, as well as a test cycle which quickly checks the functionality of all of the components. To perform these operations it is necessary to set the machine to "programming mode" as described hereafter

- Shut the machine off by pressing 
- Simultaneously press  and  until **P0** appears on the display
- With the  button (ahead) and the  button (back) select the programs
- Once the parameter to modify has been identified, keep the  button pressed and modify the required setting with the "ahead"  and "back"  buttons
- Once the setting has been correctly modified, release the  button
- When finished with the settings turn the machine off and on again by pressing 

Note: always turn on the DRAIN PUMP function in machines with Air Tank or Break Tank even if absent.

IN PARAMETERIZATION MODE, IF NO BUTTON IS PRESSED WITHIN 30 SECONDS THE KEYBOARD SHUTS DOWN AND RETURNS TO ITS OFF STATE.

Regeneration mode:

Once having reached the set number of cycles, at the end of the last cycle (ex. The 20th or the 35th, etc.) the message rig will appear flashing on the display for 10"; if it is desired to continue and the request is ignored, the message will appear for 10" at the end of every cycle.

The regeneration phase only begins after the Tank Pressostat has arrived at empty

- 1) EVR active for 20", 1' break – repeat EV regenerate activation 4 times
- 2) 8' break
- 3) EV1 active for 25", 1' break - repeat EV load activation 4 times, PS activation (drain pump) contextually to EV load + 5"

Afterwards, once the first samples are available, verify the correctness of the times/actual regeneration and proper resin washing.

At the end of the regeneration, the display goes back to showing the last program performed and the machine is once again ready for use.

Note: the regeneration cycle can be cancelled once initiated by keeping the  button pressed for 10 seconds.

7 SCREEN DISPLAYED ANOMALIES

After having turned the machine off and on again, if the problem persists communicate the type of error displayed on the screen to technical assistance:

E1	Boiler sensor malfunction
E2	Tank sensor malfunction
E3	Water loading timeout (the water loading duration has exceeded the set time)
E6	Draining anomaly. At the end of the draining phase the CPU still detects water in the Tank. This may be due to: Drain pump malfunction (if present), drain tube blockage, Tank Pressostat malfunction, drain cycle time set too low, Tank overflow inserted
E7	30 minute Tank timeout
E8	15 minute boiler timeout

8 USER INSTRUCTIONS FOR MODELS:

CW400R - CW400RSD

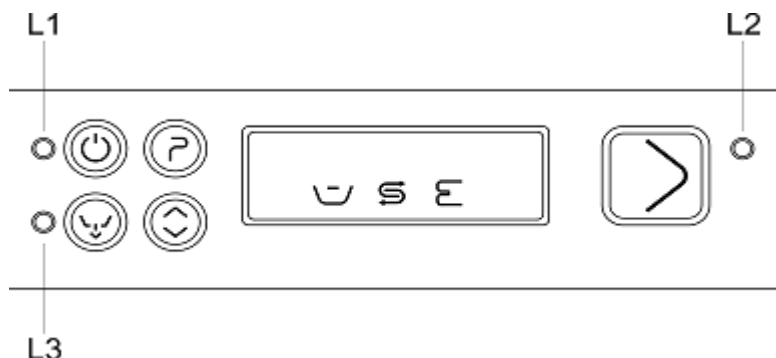

	On/Off button
	Program selection button
	Start button CONFIRM/PAUSE
	Complete emptying button (Tank and boiler)
	Additional functions selection button
	L1 Power supply indicator light
	L2 Cycle in function indicator light input/waiting (red/green)
	L3 Draining in function indicator light
	Tank resistance in function symbol
	Insufficient salt symbol (only if water-softener present)
	Boiler resistance in function symbol

8.1 Before washing

Use only detergents and rinse-aids for industrial dishwashers.

Do not use detergents intended for hand washing.

It is recommended to use products which were designed especially for this dishwasher.



During the loading of the tanks be careful not to switch products as this could provoke dishwasher malfunction and damage.

Do not mix different detergents together as this could damage the metering unit.

Detergents for industrial dishwashers can cause serious irritations. Take care to respect the instructions provided by the detergent manufacturer on the packaging.

Open the water supply faucet (usage).	Verify:		Turn off the main switch (usage), "OFF" appears on the display.
	The levels of detergent and rinse-aid in the containers.	The correct positioning of the filters, the rotation of the sprinklers, the absence of foreign objects within the dishwasher.	











LOADING GLASSES:

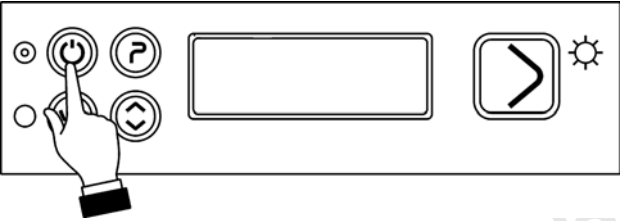

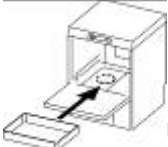
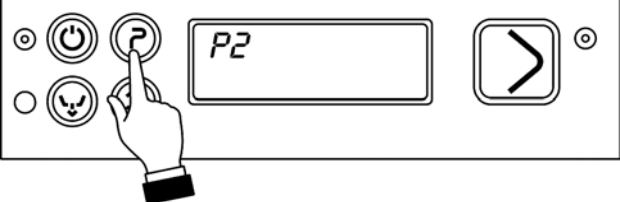

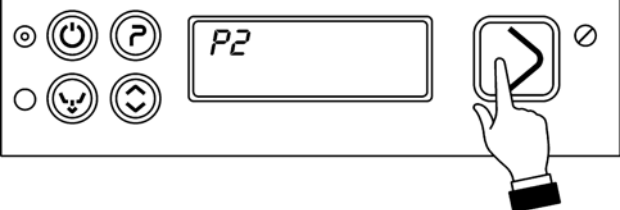
Remove eventual solid residues from the glasses (peels, cores, etc.).
Position the glasses upside down.

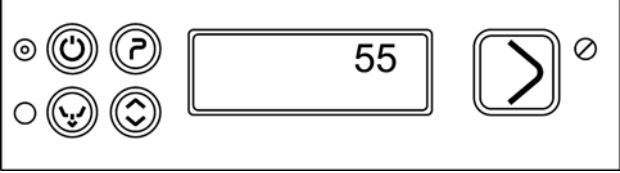
Silverware

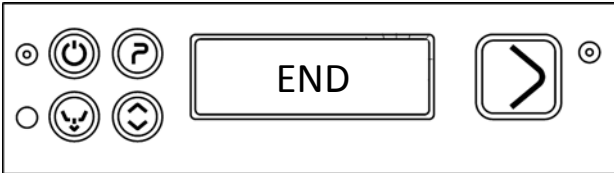

Use the appropriate basket. It is preferable to arrange large amounts of silverware with the handles facing down, taking care to avoid injury from fork prongs and knife blades.

8.2 FIRST DAILY USE (Tank and boiler empty) Mod. CW400RSD – CW400R

Visualization	What to do and what happens
	<p>Activate the wall switch. Three green dashes appear on the display ---; the  led indicator will turn green to indicate that the machine is receiving electrical current while the  led indicator will turn red.</p>
	<p>Open the door, insert the overflow and close the door: Press . Water loads into the Tank and boiler. Once the boiler and Tank have been filled the  led indicator will turn green.</p>
	<p>Basket insertion</p>
	<p>Select the desired program by pressing :</p> <ul style="list-style-type: none"> P1 Brief cycle P2 Medium cycle (crystal cycle) P3 Long cycle P4 Continuous cycle
	<p>Confirm the start of the program by pressing  (the led indicator turns red).</p>
	<p>Cycle in function. At first the wash temperature is displayed and afterwards the rinse temperature is displayed. If the door is opened the program stops. Once the door is closed again the program resets itself. Press  to restart the program.</p>

	<p>Once the program has finished the message “END” appears on the display. The  led indicator remains red.</p>
	<p>Basket removal</p>
<p>By closing the door the last executed program is proposed again and the  led indicator turns green</p>	

Note:

While the water in the boiler and in the Tank is heating up, the display may show the Tank resistance  and boiler resistance  symbols.





8.3 PROGRAM SELECTION

PROGRAM	DURATION(*)
P1	Brief about 1'
P2	Medium about 2' (crystals cycle)
P3	Long about 3'
P4	Continuous from 0 to 10'

(*)The cycle durations indicated above are based upon a tri-phase connection with a 50°C hot water supply.

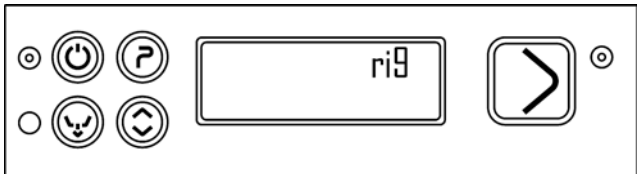
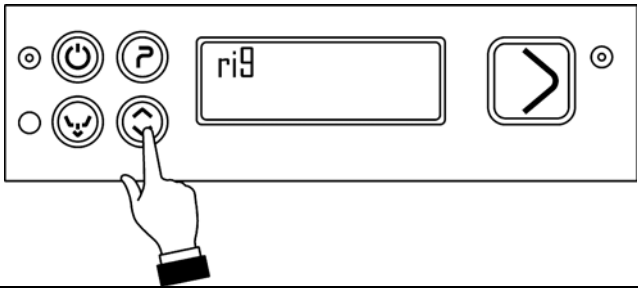
Where a cold water supply is used, the duration of the cycle could increase in relation to the input water temperature since the dishwasher is equipped with a constant temperature and pressure rinse system.

8.4 RESIN CYCLE (for models equipped with water-softeners)

	<p>Upon reaching the number of set cycles the message “ri9” appears flashing on the display for 10”; if a subsequent cycle is performed, and the request is ignored, the message reappears for 10” at the end of every cycle.</p>
	<p>When the machine is on with the Tank either full or empty press the  button until the “ri9” message appears.</p> <p>Open the door and remove the overflow. Close the door again and hold down the  button to empty the Tank and the boiler. The  drain led indicator will flash until draining has been completed.</p>

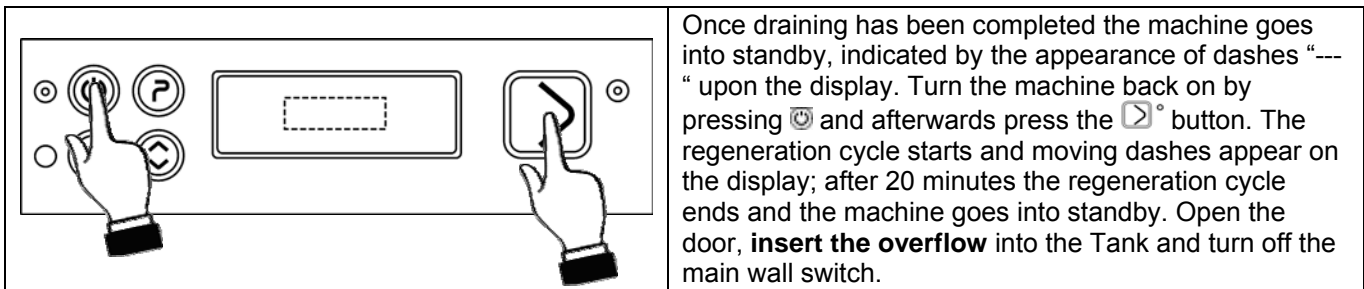

During the execution of the regeneration cycle it will not be possible to perform any operations. It must always be done with the Tank empty.

Refilling the supply of regenerating salt (for models equipped with water softeners)

The refill is to be performed once the insufficient salt indicator appears on the display () .

Perform the salt refill **when there is no water in the Tank** in order to keep wash water from entering the water softener device.

Caution: Use only specific salt. Do not use table salt.

The salt tank has a capacity of about **1 kg of granulated salt**.

The tank is situated at the bottom of the Tank. After having extracted the basket, unscrew the cap and pour the salt through the provided funnel. Before screwing the cap back in place remove any eventual salt residues in proximity to the opening.

8.5 Total drainage at the end of the day

The dishwasher is capable of performing an auto-clean cycle at the end of the day.

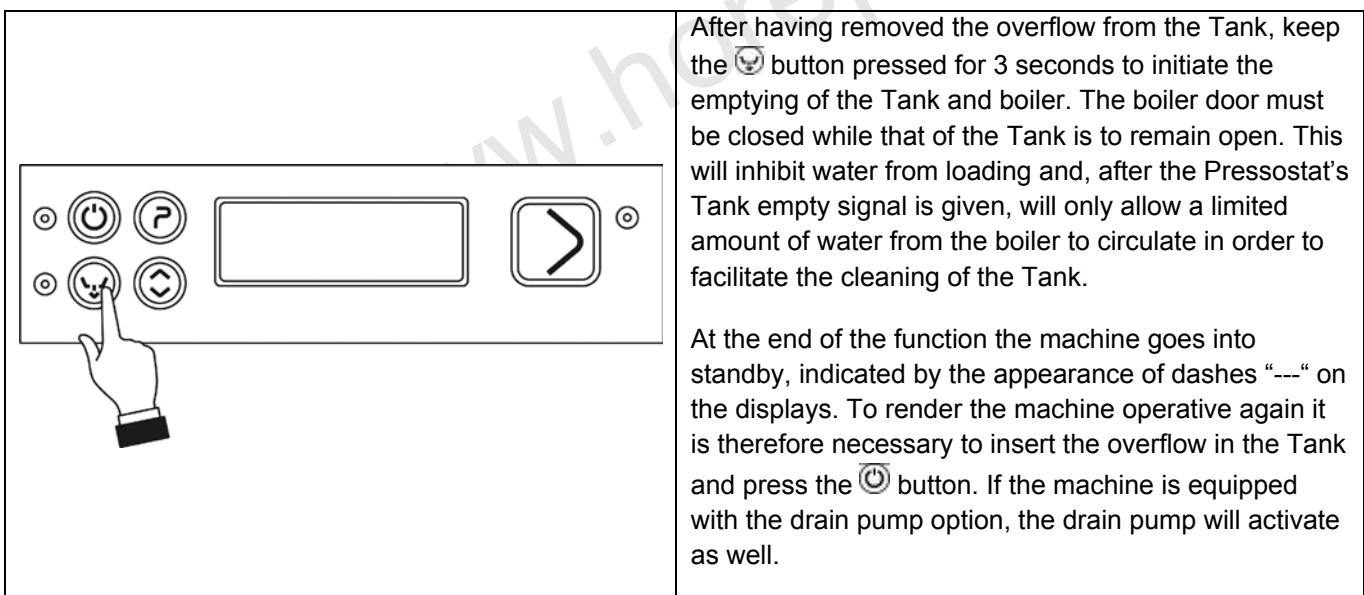

Do not turn off the washing machine while the Tank is full. Always drain it first.

9 USER INSTRUCTIONS FOR MODELS:

CW350B-CW350BSD-CW350-CW350SD-CW400B-CW400BSD

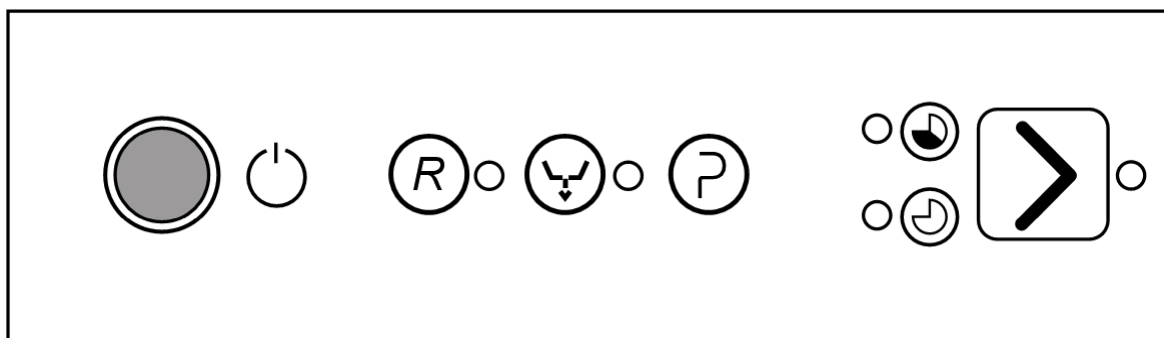

	On / Off button
	Basin emptying button (only in models with drain pump)
	Regeneration cycle
	Wash program selection button
	Start cycle button
	Brief cycle led indicator
	Long cycle led indicator
	Led indicator functions
	Led indicator portrayals: off; green; red; flashing

9.1 Before washing

Use only detergents and rinse-aids for industrial dishwashers.

Do not use detergents intended for hand washing.



It is recommended to use Smeg products which were designed especially for this dishwasher.



During the loading of the tanks be careful not to switch products as this could provoke dishwasher malfunction and damage.

Do not mix different detergents together as this could damage the metering unit.

Detergents for industrial dishwashers can cause serious irritations. Take care to respect the instructions provided by the detergent manufacturer on the packaging.

<p>Open the water supply faucet (usage).</p>	<p>The levels of detergent and rinse-aid in the containers.</p>	<p>Verify:</p> <p>The correct positioning of the filters, the rotation of the sprinklers, the absence of foreign objects within the dishwasher.</p>	<p>Turn off the main switch (usage), "OFF" appears on the display.</p>
			









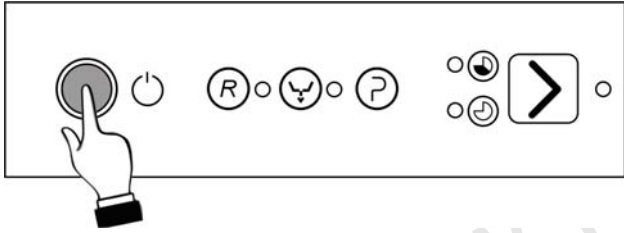

LOADING GLASSES:

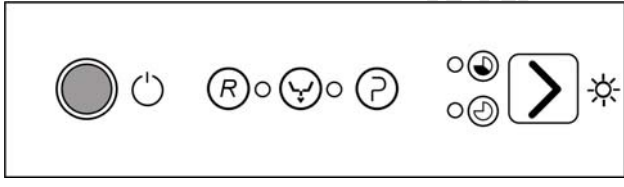



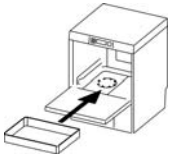
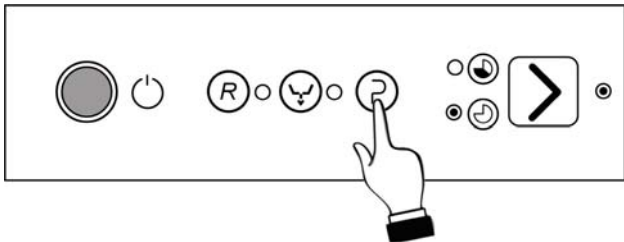





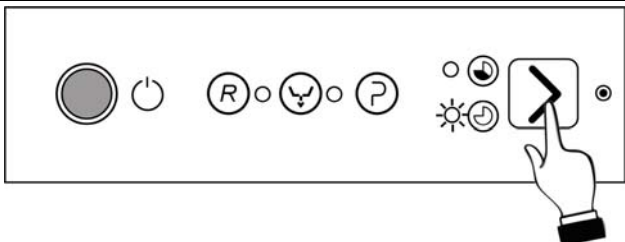

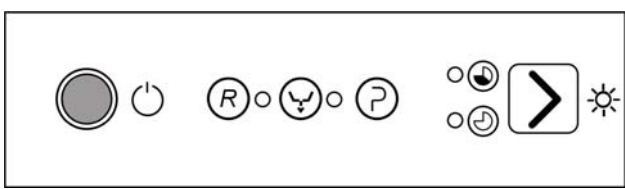

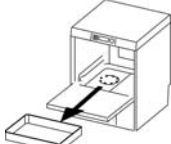
Remove eventual solid residues from the glasses (peels, cores, etc.).
Position the glasses upside down.

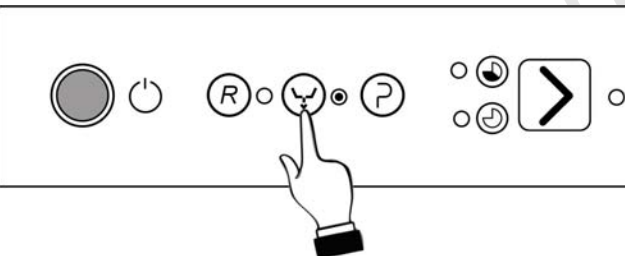
Silverware

Use the appropriate basket. It is preferable to arrange large amounts of silverware with the handles facing down, taking care to avoid injury from fork prongs and knife blades.

9.2 FIRST DAILY USE (basin and boiler empty) CW350B-CW350BSD-CW350-CW350SD-CW400B-CW400BSD

<p>Visualization</p>	<p>What to do and what happens</p>
	<p>Activate the wall switch to provide electrical current to the machine. Open the door, insert the overflow, close the door and press the  button.</p>
	<p>When water is loading into the boiler and into the basin, the  and  led indicators flash; when loading has been completed  flashes and the brief cycle selection led indicator  turns on.</p>
	<p>Insert the basket</p>
	<p>Select the desired program by pressing :</p> <ul style="list-style-type: none">  for the 90 second brief cycle  for the 120 second medium cycle <p>Note The wash cycle cannot be started if:</p> <ul style="list-style-type: none"> The basin water level is not complete The door is open The machine is off The machine is in regeneration phase Manual draining is taking place <p>Once electrical current is present the  led indicator turns on</p>

	<p>Confirm the initiation of the program by pressing . While the cycle is running the selected program's led indicator will flash;</p>
	<p>Once the selected program has finished its led indicator will stop flashing and will remain on. The * led indicator starts flashing.</p>
	<p>Remove the basket</p>
<p>If the door is opened with the wash cycle running the program stops and resets itself. Once the door has been closed again press the  button to restart the cycle.</p>	
	<p>Total drainage at the end of the day (models equipped with drain pump) After having removed the overflow from the basin, close the door and press the  button to select the option. The  led indicator turns on and the * LED indicator flashes. Press * for 2 seconds to initiate the emptying of the basin and the boiler with the door closed. The drain led indicator  starts flashing. At the end of the function the machine goes into standby and the drain led indicator stops flashing and remains on. To render the machine operational again it is therefore necessary to insert the overflow and to push the  button.</p> <p>Total drainage at the end of the day (models not equipped with drain pump) Shut off the machine , open the door, remove the overflow and wait until the basin has been drained. Insert the overflow and close the door again.</p>

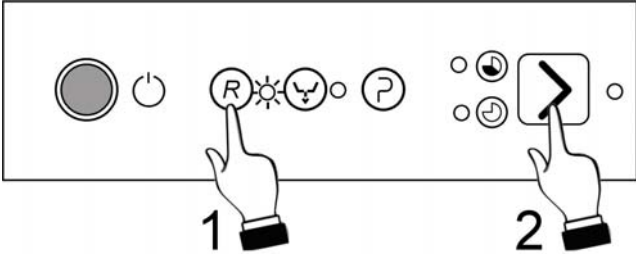
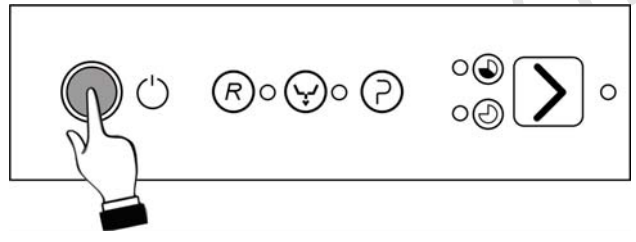
 <p>1</p> <p>2</p>	<p>Regeneration cycle (for models equipped with water softeners)</p> <p>For models equipped with drain pumps, perform a drain cycle before executing the regeneration cycle. For models not equipped with drain pumps, remove the overflow and close the door.</p> <p>Press the R button to select the option. The R led indicator turns on and the ▶* led indicator flashes. Hold down the ▶* button for two seconds to initiate the regeneration cycle. During the regeneration cycle the R and ⚙ led indicators flash.</p> <p>If the door is opened at any time the regeneration cycle stops along with any filling operations. When the door is closed again the cycle starts from where it left off. After 20 minutes the regeneration cycle finishes and the machine remains in standby with the R and ⚙ led indicators steadily on.</p> <p>Open the door, insert the overflow into the basin and turn off the main wall switch.</p>
<p>During the execution of the regeneration cycle it will not be possible to perform any operations.</p> <p>Refilling the supply of regenerating salt (for models equipped with water softeners)</p> <p>Perform the salt refill when there is no water in the basin in order to keep wash water from entering the water softener device.</p> <p>Caution: Use only specific salt. Do not use table salt.</p> <p>The salt tank has a capacity of about 1 kg of granulated salt.</p> <p>The tank is situated at the bottom of the basin. After having extracted the basket, unscrew the cap and pour the salt through the provided funnel. Before screwing the cap back in place remove any eventual salt residues in proximity to the opening.</p>	
	<p>Once having finished using the machine, and after having performed the final draining and eventual regeneration, shut off the machine by pressing the ⏻ button and turn off the wall switch.</p>

10 MAINTENANCE AND CLEANING

Notwithstanding that special, programmed maintenance is not required, we recommend having the dishwasher checked by a specialized technician twice a year.

Note: intentional damage or that derived from carelessness, negligence, lack of respect for the regulations, instructions and norms or erred connections are not to be considered the responsibility of the manufacturer.

10.1 Daily cleaning

The dishwasher has an **IPX4** protection rating, but the use of direct streams of water for its cleaning is **forbidden**.

Cleaning of the filter during the day

In case of particularly heavy usage it is recommended to perform a cleaning of the filter every 30-40 wash cycles in order to maintain the machine in operative conditions; Use "partial Tank draining" in order to perform these cleanings.

Remove the filters (it is sufficient to lift them out of their lodgings as shown in the figure), making sure that greasy residues do not fall into the opening underneath the filters. Clean away the residues and rinse the filters abundantly before correctly reinserting them; Do not utilize pointy or sharp objects for cleaning.

Be sure to remove eventual hardened calcium deposits in order to avoid their accumulation;

- Clean the surfaces well and frequently with a damp rag; use neutral, non-abrasive detergents which do not contain chlorine-based substances. Corrosive products can damage stainless steel.

In order to avoid drops or vapors damaging the steel surfaces, do not even use the above-indicated products for the cleaning of the flooring beneath or around the dishwasher.

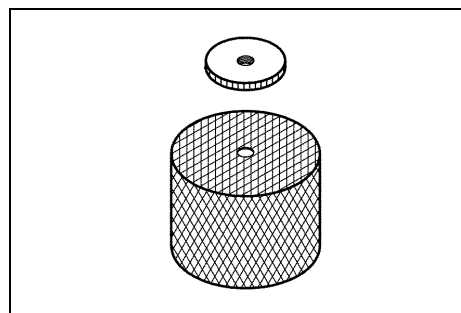

10.2 Periodic checks

Disassemble the sprinklers (lower and upper 2-4) by removing the central screw (4); unscrew the caps at the two far ends of the rinsing sprinklers (7).

Clean the holes and the nozzles under a stream of clean water. Do not use utensils which could cause damage. Carefully reassemble the sprinklers.

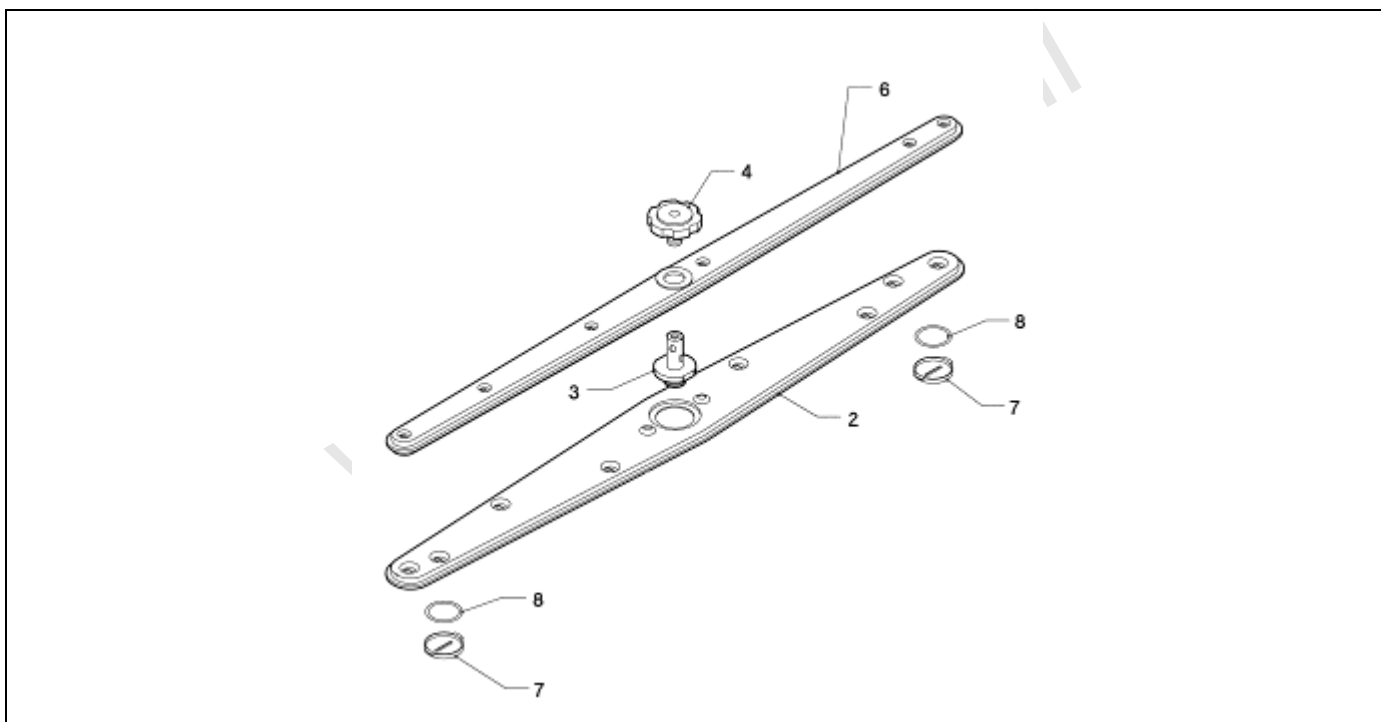

Clean the outside of the machine with neutral soap and a damp cloth. Rinse and dry with care.

10.3 Prolonged disuse

If the use of the dishwasher is not foreseen for a relatively long period of time **it is necessary to drain the detergent and rinse-aid dispenser in order to avoid crystallization and pump damage:** Remove the suction tubes from the detergent and rinse-aid containers and immerse them in a container filled with clean water. Perform a few wash cycles and drain the machine completely.

Finally, turn off the main switch and close the water supply faucet. The detergent and rinse-aid suction tubes will be placed back in the containers when the machine is ready to be put back in use, **taking care so as not to invert the tubes (red tube = detergent; transparent tube = rinse-aid).**

Do not leave the device on, inactive and in disuse for long periods of time.



11 PROBLEMS AND ANOMALIES (USER)



PROBLEM	POSSIBLE CAUSE	POSSIBLE REMEDY
THE L1 LED INDICATOR DOES NOT TURN ON	There is no electrical current	Verify the electrical current connection.
THE WASH PROGRAM DOES NOT START	The dishwasher has not finished loading	Wait for the  led indicator to turn red.
POOR WASHING RESULTS	Sprinkler wash holes are clogged or encrusted	Disassemble and clean the sprinklers (10.2 Periodic checks)
	Detergent or rinse-aid insufficient or not adequate	Verify detergent type and quantity.
	Plates / glasses poorly positioned	Arrange plates / glasses accordingly.
	Low wash temperature	Verify the temperature shown on the display, if below 50°C call Assistance.
	Inadequate cycle setting	Increase the duration of the wash cycle, particularly if dishes are very dirty or contain partially dried residues.
RINSE INSUFFICIENT	Sprinkler nozzles clogged Calcium encrustations in the boiler	Verify the cleanliness of the nozzles and the correct function of any installed water softeners.
GLASSES AND SILVERWARE ARE STAINED	Rinse-aid inadequate or not dispensed correctly. Water is of a hardness level above 12°F or contains many dissolved salts	Verify the rinse-aid container and ensure its adequacy for use with the water supply. If the problem persists contact assistance.
WATER IS PRESENT IN THE TANK AFTER DRAINING	Drainage tube is positioned poorly or is partially blocked	Verify that the dishwasher's tube and drain are not blocked and that the drain is not in too high of a position; see the connection diagram.

12 SCREEN DISPLAYED ANOMALIES (USER)

The machine is capable of signaling a series of malfunctions on the display.

If the problem persists after having turned the machine off and then on again, act as indicated below:

E1	Boiler sensor malfunction	Consult with the Technical Assistance Service
E2	Tank sensor malfunction	Consult with the Technical Assistance Service
E3	Water loading timeout (the water loading duration has exceeded the set time)	Verify that the water supply faucet is open, the dynamic pressure of the supply and the cleanliness of the water input filter. If the problem persists consult with the Technical Assistance Service.
E6	Draining anomaly. At the end of the draining phase the CPU still detects water in the Tank. This may be due to: Drain pump malfunction (if present), drain tube blockage, Tank Pressostat malfunction, drain cycle time set too low, overflow inserted in the Tank	Verify the cleanliness of the filters and that the drain tube is not blocked, bent or crushed. Verify that the drain pump is not blocked by a foreign object: act as indicated in point "10.2 Periodic Checks". If the problem persists consult with the Technical Assistance Service.
E7	30 minute Tank timeout	Consult with the Technical Assistance Service
E8	15 minute boiler timeout	

Mod. CW400RSD

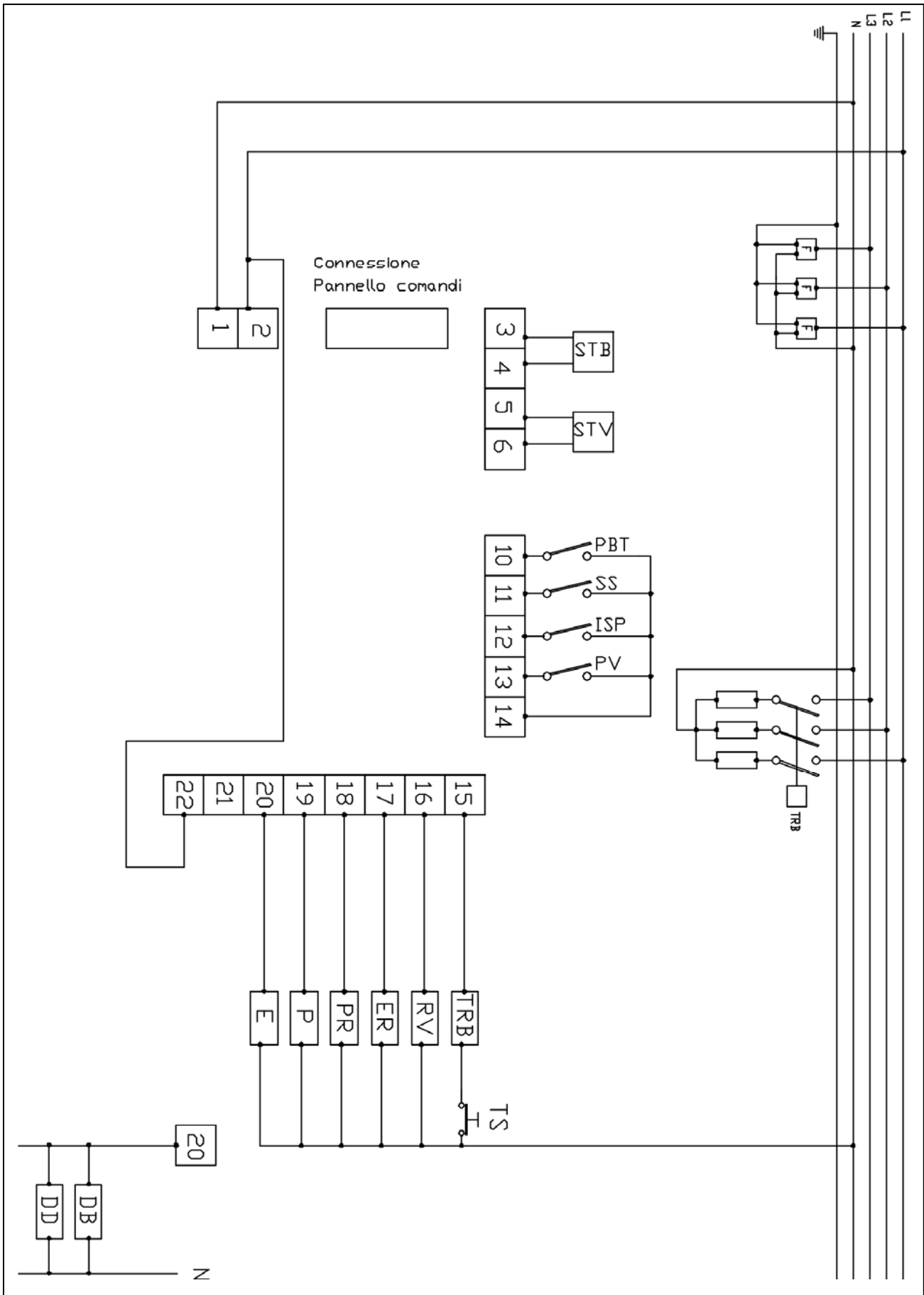

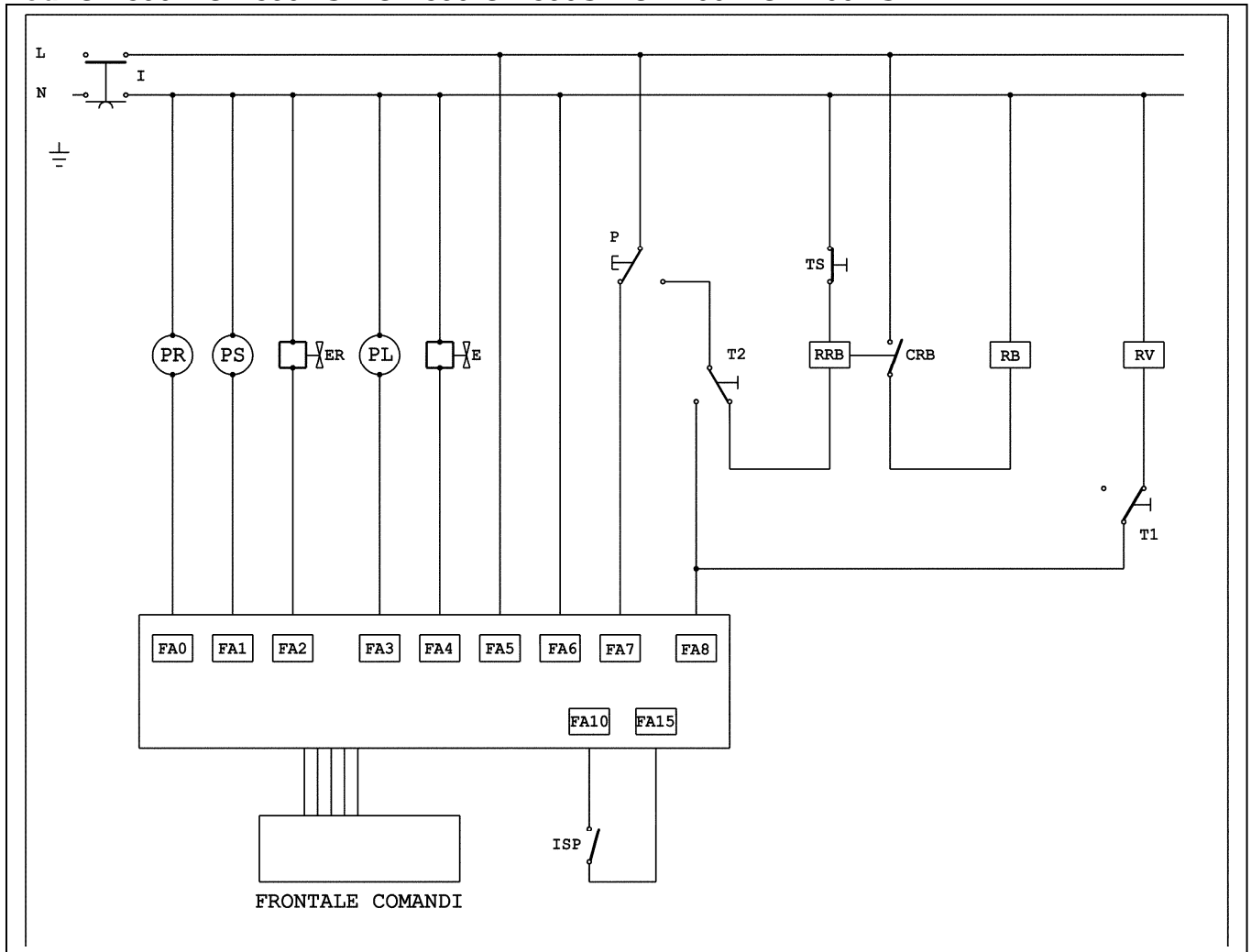
Mod. CW350B-CW350BSD-CW350-CW350SD-CW400B-CW400BSD

	Schaltplan – Legende	Schéma électrique – légende
PV	Druckregler Tank	Pressostat cuve
ISP	Sicherheitsschalter Tür	Interrupteur de sécurité Porte
STV	Temperatursonde Tank	Sonde de température cuve
STB	Temperatursonde Boiler	Sonde de température chauffe-eau
TRB	Fernschalter Boiler-Heizkörper (Spule)	Télerupteur résistance chauffe-eau (bobine)
TRV	Fernschalter Tank-Heizkörper (Spule)	Télerupteur résistance cuve (bobine)
E	Nachspül-Magnetventil	Electrovanne de rinçage
DB	Klarspüler-Dosierer	Doseur liquide de rinçage
P	Waschpumpe	Pompe de lavage
DD	Spülmittel-Dosierer	Doseur produit de lavage
PBT	Druckregler Break Tank	Pressostat Break Tank
PR	Nachspül-Pumpe	Pompe de rinçage
TP	Fernschalter Waschpumpe (Spule)	Télerupteur pompe de lavage (bobine)
TPL	Überlastschutz Spülpumpe	Relais thermique pompe de lavage
TS	Sicherheitsthermostat	Thermostat de sécurité
F	Funkentstörung	Filtres antiparasites

	Schema elettrico – legenda	Electrical scheme – legend
PV	Pressostato Vasca	Basin Manostat
ISP	Interruttore Sicurezza Porta	Door Safety Switch
STV	Sonda Temperatura Vasca	Basin Temperature Sensor
STB	Sonda Temperatura Boiler	Boiler Temperature Sensor
TRB	Teleruttore Resistenza Boiler (Bobina)	Boiler Resistance Remote Control Switch (Coil)
TRV	Teleruttore Resistenza Vasca (Bobina)	Basin Resistance Remote Control Switch (Coil)
E	Elettrovalvola Risciacquo	Rinse Electrovalve
DB	Dosatore Brillantante	Rinse-aid Metering Unit
P	Pompa Lavaggio	Wash Pump
DD	Dosatore Detergente	Detergent Metering Unit
PBT	Pressostato Break Tank	Break Tank Manostat
PR	Pompa Risciacquo	Rinse pump
TP	Teleruttore Pompa Lavaggio (Bobina)	Wash Pump Remote Control Switch (Coil)
TPL	Termica Pompa Lavaggio	Wash Pump Thermal
TS	Termostato Sicurezza	Safety Thermostat
F	Filtri Antidisturbo	Antistatic filters

	Esquema eléctrico - legenda	Diagrama eléctrico - leyenda
PV	Pressostáto Tanque	Presostato tanque
ISP	Interruptor de Segurança da Porta	Interruptor de seguridad puerta
STV	Sonda da Temperatura do Tanque	Sonda Temperatura Tanque
STB	Sonda da Temperatura do Esquentador	Sonda Temperatura hervidor
TRB	Telerruptore Resistência Esquentador (Bobina)	Telerruptor Resistencia hervidor (bobina)
TRV	Telerruptore Resistência Tanque (Bobina)	Telerruptor Resistencia Tanque (bobina)
E	Electroválvula Enxaguamento	Electroválvula de enjuague
DB	Dosador de abrilhantador	Dosificador abrillantador
P	Bomba Lavagem	Bomba de lavado
DD	Dosador Detergente	Dosificador detergente
PBT	Pressostáto Break Tank	Presostato Tanque de separación
PR	Bomba Enxaguamento	Bomba de enjuague
TP	Telerruptor Bomba Lavagem (Bobina)	Telerruptor bomba de lavado (Bobina)
TPL	Térmica Bomba Lavagem	Térmico bomba de lavado
TS	Termostáto de Segurança	Termostato de seguridad
F	Filtros Anti disturbo	Filtros antiparásito

Mod. CW350B

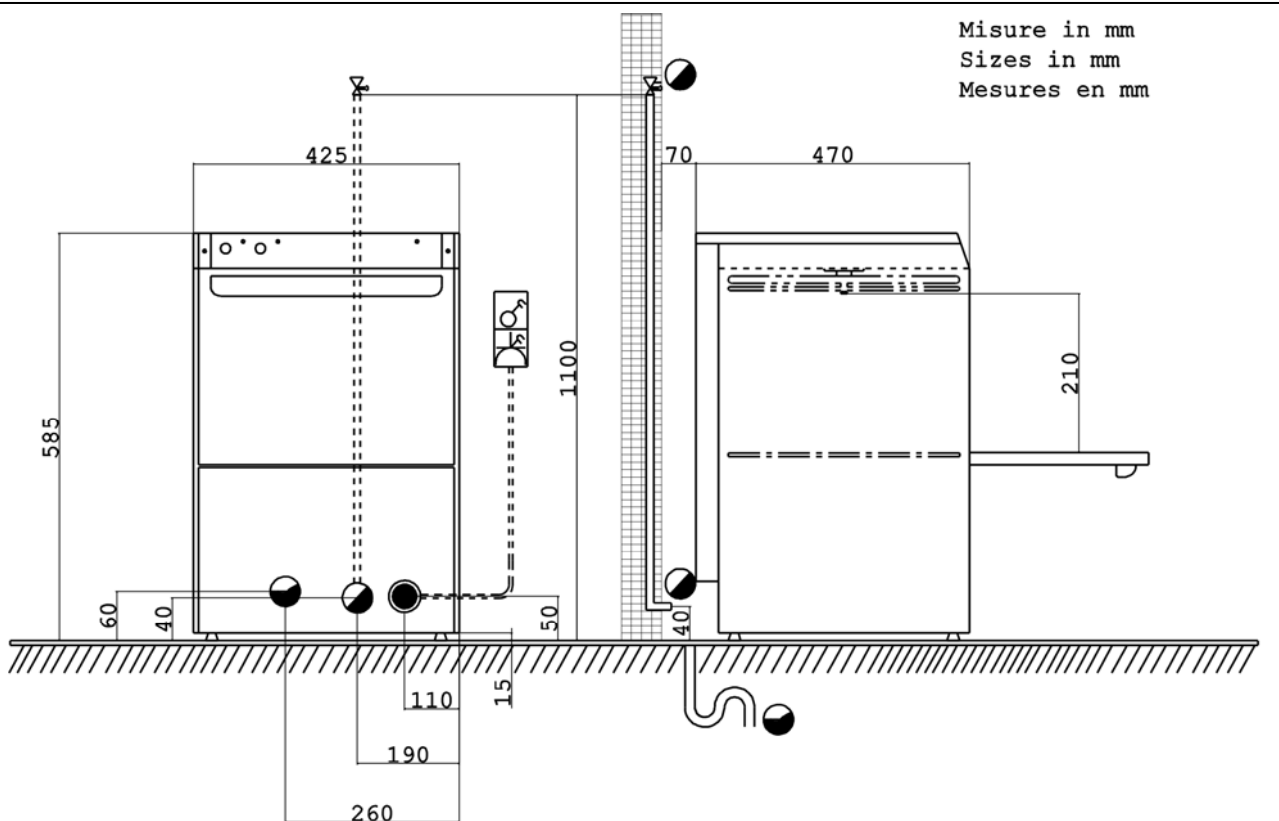

Misure in mm
 Sizes in mm
 Mesures en mm

MODELLO	MODEL	MODELE	kW
CW 350 B			2.9

● Allacciamento elettrico - Electrical connection Branchement électrique - Elektroanschluss		⊕ Morsetto equipotenziale - Equipotential terminal Borne équipotentiel - Potentialausgleichsklemme		NON IN DOTAZIONE NOT INCLUDED PAS EN DOTATION NICHT DABEI																																								
<table border="1"> <tr> <td>3</td> <td>☑</td> </tr> </table> Morsettiera Terminal board Plaque à bornes Klemmenbrett	3	☑	V Hz A	<table border="1"> <tr> <td>●</td> <td>Ingresso acqua calda Hot water inlet Entrée eau chaude Wamwassereintritt</td> <td> <table border="1"> <tr> <td>bar</td> <td>∅</td> </tr> <tr> <td>KPa</td> <td>L/h</td> </tr> <tr> <td>3</td> <td></td> </tr> <tr> <td>300</td> <td></td> </tr> </table> </td> <td> Rubinetto di intercettazione Isolator valve Robinet de barrage Absperrhahn </td> </tr> <tr> <td> <table border="1"> <tr> <td>1</td> <td>☑</td> </tr> </table> Morsettiera Terminal board Plaque à bornes Klemmenbrett </td> <td> V Hz A </td> <td> <table border="1"> <tr> <td>○</td> <td>Ingresso acqua fredda cold water inlet Entrée eau froide kaltwassereintritt</td> <td> <table border="1"> <tr> <td>bar</td> <td>∅</td> </tr> <tr> <td>KPa</td> <td>L/h</td> </tr> <tr> <td>3</td> <td></td> </tr> <tr> <td>300</td> <td></td> </tr> </table> </td> <td> <table border="1"> <tr> <td>⊕</td> <td>Interruttore magnetotermico differenziale Differential magnetothermic switch Interrupteur magnétothermique différentiel Magnetothermischer differentialschalter</td> </tr> </table> </td> </tr> <tr> <td> <table border="1"> <tr> <td>~N*</td> <td>Cavo elettrico Electrical cable Câble électrique Elektrokabel</td> <td> V Hz mm² </td> <td> <table border="1"> <tr> <td>●</td> <td>Scarico acqua Water drain</td> <td> Vidange eau WasserAbflub </td> <td> ∅ </td> </tr> </table> </td> </tr> </table></td></tr></table></td></tr></table>	●	Ingresso acqua calda Hot water inlet Entrée eau chaude Wamwassereintritt	<table border="1"> <tr> <td>bar</td> <td>∅</td> </tr> <tr> <td>KPa</td> <td>L/h</td> </tr> <tr> <td>3</td> <td></td> </tr> <tr> <td>300</td> <td></td> </tr> </table>	bar	∅	KPa	L/h	3		300		Rubinetto di intercettazione Isolator valve Robinet de barrage Absperrhahn	<table border="1"> <tr> <td>1</td> <td>☑</td> </tr> </table> Morsettiera Terminal board Plaque à bornes Klemmenbrett	1	☑	V Hz A	<table border="1"> <tr> <td>○</td> <td>Ingresso acqua fredda cold water inlet Entrée eau froide kaltwassereintritt</td> <td> <table border="1"> <tr> <td>bar</td> <td>∅</td> </tr> <tr> <td>KPa</td> <td>L/h</td> </tr> <tr> <td>3</td> <td></td> </tr> <tr> <td>300</td> <td></td> </tr> </table> </td> <td> <table border="1"> <tr> <td>⊕</td> <td>Interruttore magnetotermico differenziale Differential magnetothermic switch Interrupteur magnétothermique différentiel Magnetothermischer differentialschalter</td> </tr> </table> </td> </tr> <tr> <td> <table border="1"> <tr> <td>~N*</td> <td>Cavo elettrico Electrical cable Câble électrique Elektrokabel</td> <td> V Hz mm² </td> <td> <table border="1"> <tr> <td>●</td> <td>Scarico acqua Water drain</td> <td> Vidange eau WasserAbflub </td> <td> ∅ </td> </tr> </table> </td> </tr> </table></td></tr></table>	○	Ingresso acqua fredda cold water inlet Entrée eau froide kaltwassereintritt	<table border="1"> <tr> <td>bar</td> <td>∅</td> </tr> <tr> <td>KPa</td> <td>L/h</td> </tr> <tr> <td>3</td> <td></td> </tr> <tr> <td>300</td> <td></td> </tr> </table>	bar	∅	KPa	L/h	3		300		<table border="1"> <tr> <td>⊕</td> <td>Interruttore magnetotermico differenziale Differential magnetothermic switch Interrupteur magnétothermique différentiel Magnetothermischer differentialschalter</td> </tr> </table>	⊕	Interruttore magnetotermico differenziale Differential magnetothermic switch Interrupteur magnétothermique différentiel Magnetothermischer differentialschalter	<table border="1"> <tr> <td>~N*</td> <td>Cavo elettrico Electrical cable Câble électrique Elektrokabel</td> <td> V Hz mm² </td> <td> <table border="1"> <tr> <td>●</td> <td>Scarico acqua Water drain</td> <td> Vidange eau WasserAbflub </td> <td> ∅ </td> </tr> </table> </td> </tr> </table>	~N*	Cavo elettrico Electrical cable Câble électrique Elektrokabel	V Hz mm ²	<table border="1"> <tr> <td>●</td> <td>Scarico acqua Water drain</td> <td> Vidange eau WasserAbflub </td> <td> ∅ </td> </tr> </table>	●	Scarico acqua Water drain	Vidange eau WasserAbflub	∅
3	☑																																											
●	Ingresso acqua calda Hot water inlet Entrée eau chaude Wamwassereintritt	<table border="1"> <tr> <td>bar</td> <td>∅</td> </tr> <tr> <td>KPa</td> <td>L/h</td> </tr> <tr> <td>3</td> <td></td> </tr> <tr> <td>300</td> <td></td> </tr> </table>	bar	∅	KPa	L/h	3		300		Rubinetto di intercettazione Isolator valve Robinet de barrage Absperrhahn																																	
bar	∅																																											
KPa	L/h																																											
3																																												
300																																												
<table border="1"> <tr> <td>1</td> <td>☑</td> </tr> </table> Morsettiera Terminal board Plaque à bornes Klemmenbrett	1	☑	V Hz A	<table border="1"> <tr> <td>○</td> <td>Ingresso acqua fredda cold water inlet Entrée eau froide kaltwassereintritt</td> <td> <table border="1"> <tr> <td>bar</td> <td>∅</td> </tr> <tr> <td>KPa</td> <td>L/h</td> </tr> <tr> <td>3</td> <td></td> </tr> <tr> <td>300</td> <td></td> </tr> </table> </td> <td> <table border="1"> <tr> <td>⊕</td> <td>Interruttore magnetotermico differenziale Differential magnetothermic switch Interrupteur magnétothermique différentiel Magnetothermischer differentialschalter</td> </tr> </table> </td> </tr> <tr> <td> <table border="1"> <tr> <td>~N*</td> <td>Cavo elettrico Electrical cable Câble électrique Elektrokabel</td> <td> V Hz mm² </td> <td> <table border="1"> <tr> <td>●</td> <td>Scarico acqua Water drain</td> <td> Vidange eau WasserAbflub </td> <td> ∅ </td> </tr> </table> </td> </tr> </table></td></tr></table>	○	Ingresso acqua fredda cold water inlet Entrée eau froide kaltwassereintritt	<table border="1"> <tr> <td>bar</td> <td>∅</td> </tr> <tr> <td>KPa</td> <td>L/h</td> </tr> <tr> <td>3</td> <td></td> </tr> <tr> <td>300</td> <td></td> </tr> </table>	bar	∅	KPa	L/h	3		300		<table border="1"> <tr> <td>⊕</td> <td>Interruttore magnetotermico differenziale Differential magnetothermic switch Interrupteur magnétothermique différentiel Magnetothermischer differentialschalter</td> </tr> </table>	⊕	Interruttore magnetotermico differenziale Differential magnetothermic switch Interrupteur magnétothermique différentiel Magnetothermischer differentialschalter	<table border="1"> <tr> <td>~N*</td> <td>Cavo elettrico Electrical cable Câble électrique Elektrokabel</td> <td> V Hz mm² </td> <td> <table border="1"> <tr> <td>●</td> <td>Scarico acqua Water drain</td> <td> Vidange eau WasserAbflub </td> <td> ∅ </td> </tr> </table> </td> </tr> </table>	~N*	Cavo elettrico Electrical cable Câble électrique Elektrokabel	V Hz mm ²	<table border="1"> <tr> <td>●</td> <td>Scarico acqua Water drain</td> <td> Vidange eau WasserAbflub </td> <td> ∅ </td> </tr> </table>	●	Scarico acqua Water drain	Vidange eau WasserAbflub	∅																	
1	☑																																											
○	Ingresso acqua fredda cold water inlet Entrée eau froide kaltwassereintritt	<table border="1"> <tr> <td>bar</td> <td>∅</td> </tr> <tr> <td>KPa</td> <td>L/h</td> </tr> <tr> <td>3</td> <td></td> </tr> <tr> <td>300</td> <td></td> </tr> </table>	bar	∅	KPa	L/h	3		300		<table border="1"> <tr> <td>⊕</td> <td>Interruttore magnetotermico differenziale Differential magnetothermic switch Interrupteur magnétothermique différentiel Magnetothermischer differentialschalter</td> </tr> </table>	⊕	Interruttore magnetotermico differenziale Differential magnetothermic switch Interrupteur magnétothermique différentiel Magnetothermischer differentialschalter																															
bar	∅																																											
KPa	L/h																																											
3																																												
300																																												
⊕	Interruttore magnetotermico differenziale Differential magnetothermic switch Interrupteur magnétothermique différentiel Magnetothermischer differentialschalter																																											
<table border="1"> <tr> <td>~N*</td> <td>Cavo elettrico Electrical cable Câble électrique Elektrokabel</td> <td> V Hz mm² </td> <td> <table border="1"> <tr> <td>●</td> <td>Scarico acqua Water drain</td> <td> Vidange eau WasserAbflub </td> <td> ∅ </td> </tr> </table> </td> </tr> </table>	~N*	Cavo elettrico Electrical cable Câble électrique Elektrokabel	V Hz mm ²	<table border="1"> <tr> <td>●</td> <td>Scarico acqua Water drain</td> <td> Vidange eau WasserAbflub </td> <td> ∅ </td> </tr> </table>	●	Scarico acqua Water drain	Vidange eau WasserAbflub	∅																																				
~N*	Cavo elettrico Electrical cable Câble électrique Elektrokabel	V Hz mm ²	<table border="1"> <tr> <td>●</td> <td>Scarico acqua Water drain</td> <td> Vidange eau WasserAbflub </td> <td> ∅ </td> </tr> </table>	●	Scarico acqua Water drain	Vidange eau WasserAbflub	∅																																					
●	Scarico acqua Water drain	Vidange eau WasserAbflub	∅																																									

Mod. CW350BS-CW350BSD

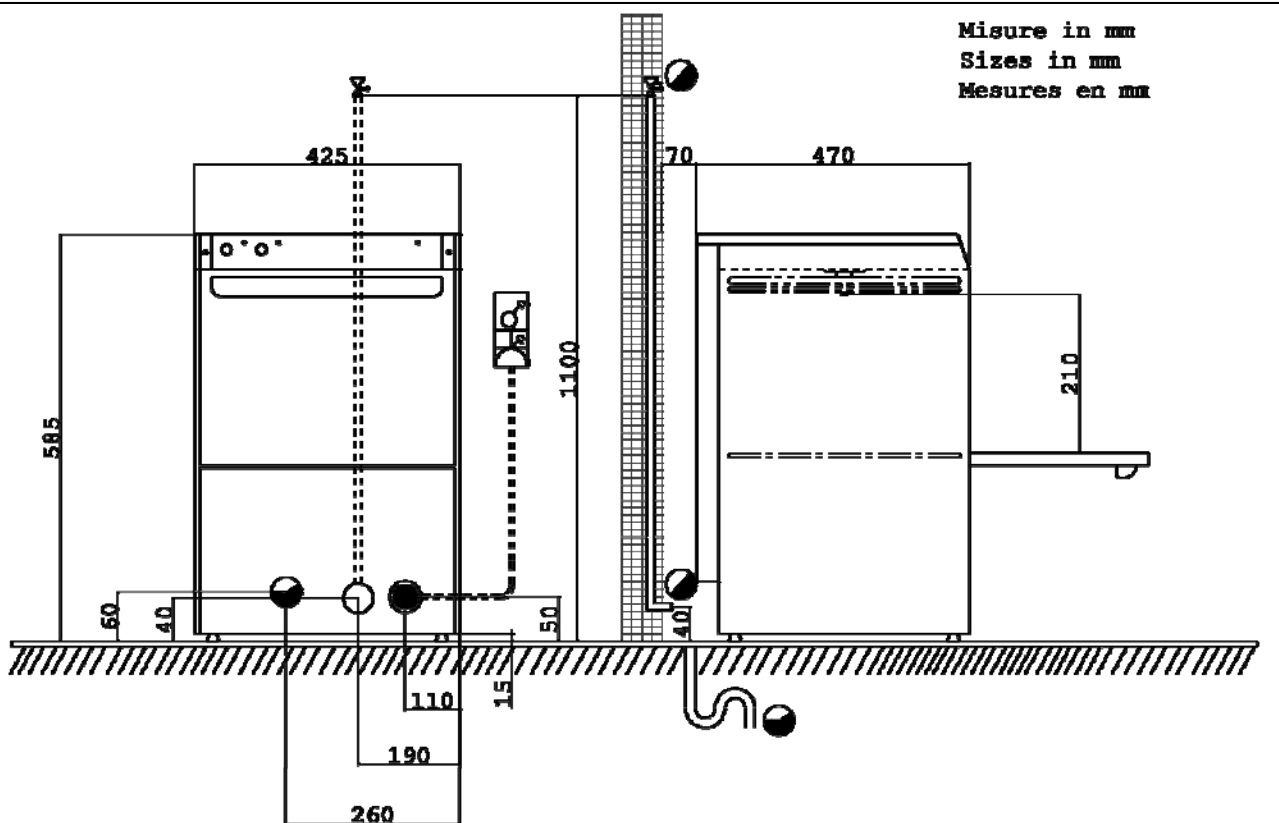

Misure in mm
 Sizes in mm
 Mesures en mm

MODELLO	MODEL	MODELE	kW
CW 350BS			2.9

Allacciamento elettrico - Electrical connection Branchement électrique - Elektroanschluss		Morsetto epipotenziale - Epipotential terminal Nuss epipotenzial - Potentzialausgleichsklemme		NON IN DOTAZIONE NOT INCLUDED ERS EN DOTATION NICHT DANCI	
Morsettiera Terminal board Plaque à bornes Klemmenbrett	V Hz A	Ingresso acqua calda Hot water inlet Entrée eau chaude Warmwassertritt	mm mm x mm	# L/h	Rubinetto di intercettazione Isolator valve Robinet de baxage Einsparbahn
Morsettiera Terminal board Plaque à bornes Klemmenbrett	V Hz A	Ingresso acqua fredda cold water inlet Entrée eau froide Kaltwassertritt	mm mm	# L/h	Interruttore magnetotermico differenziale Differential magnetothermal switch Interrupteur magnétothermique différentiel Magnetothermischer differentialschalter
Cavo elettrico Electrical cable Câble électrique Elektrokabel	V Hz mm ²	Scarico acqua Water drain Wasserabflub	mm	#	

Mod. CW350

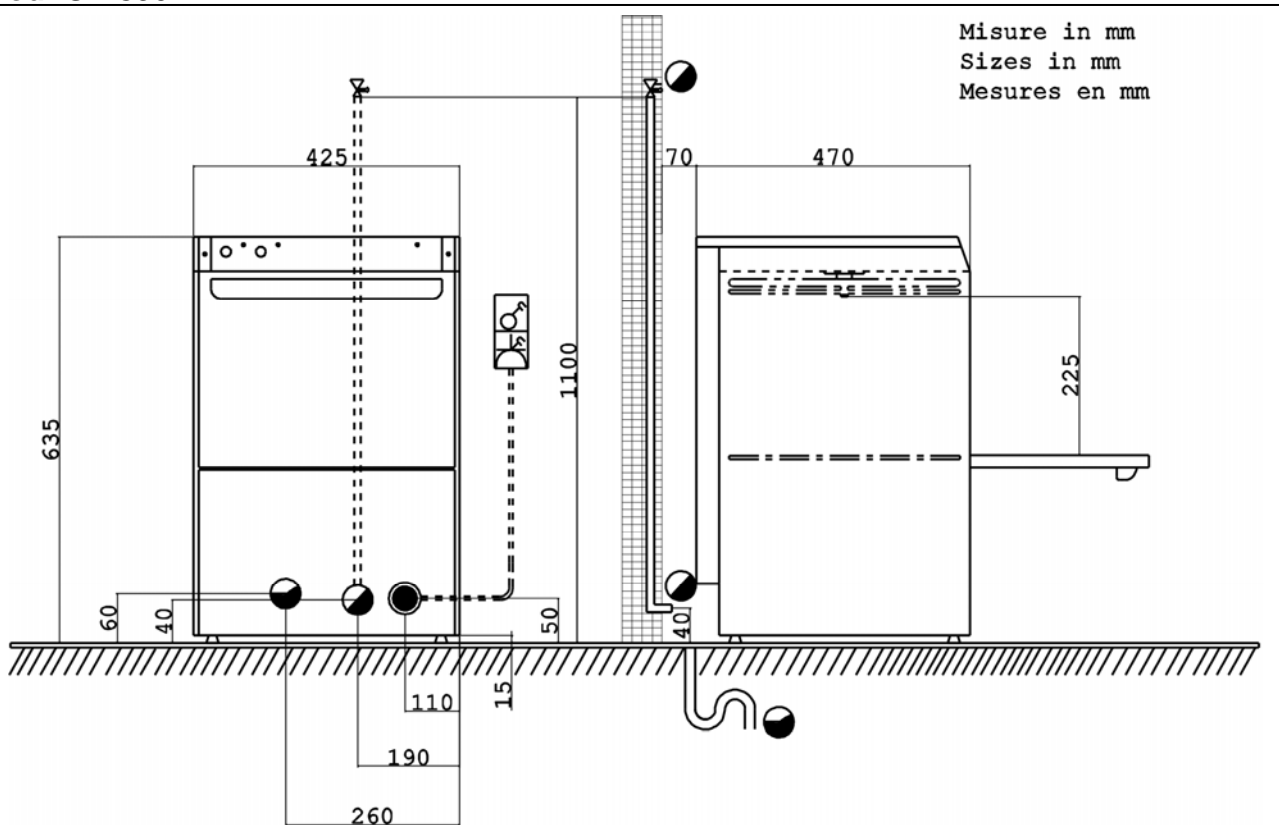

MODELLO	MODEL	MODELE	kW
CW 350			2.9

● Allacciamento elettrico - Electrical connection Branchement électrique - Elektroanschluss		⊕ Morsetto equipotenziale - Equipotential terminal Borne équipotential - Potentialausgleichsklemme		NON IN DOTAZIONE NOT INCLUDED PAS EN DOTATION NICHT DABEI																																
<table border="1"> <tr> <td>3</td> <td>Terminal board Plaque à bornes Klemmenbrett</td> <td>V</td> <td> <table border="1"> <tr> <td>●</td> <td>Ingresso acqua calda Hot water inlet Entrée eau chaude Warmwassereintritt</td> <td>bar KPa 3 300</td> <td>∅</td> <td rowspan="3"> <table border="1"> <tr> <td>⊗</td> <td>Rubinetto di intercettazione Isolator valve Robinet de barrage Absperrhahn</td> </tr> </table> </td> </tr> <tr> <td>1</td> <td>Terminal board Plaque à bornes Klemmenbrett</td> <td>V</td> <td> <table border="1"> <tr> <td>○</td> <td>Ingresso acqua fredda cold water inlet Entrée eau froide kaltwassereintritt</td> <td>bar KPa</td> <td>∅</td> </tr> <tr> <td></td> <td></td> <td></td> <td>L/h</td> </tr> </table> </td> <td rowspan="2"> <table border="1"> <tr> <td>⊗</td> <td>Interruttore magnetotermico differenziale Differential magnetothermic switch Interrupteur magnétothermique différentiel Magnetothermischer differentialschalter</td> </tr> </table> </td> </tr> <tr> <td></td> <td></td> <td></td> <td>L/h</td> </tr> </table> </td> <td> <table border="1"> <tr> <td>⊗</td> <td>Scarico acqua Water drain</td> <td>Vidange eau WasserAbflub</td> <td>∅</td> <td></td> </tr> </table> </td> </tr> </table>	3	Terminal board Plaque à bornes Klemmenbrett	V	<table border="1"> <tr> <td>●</td> <td>Ingresso acqua calda Hot water inlet Entrée eau chaude Warmwassereintritt</td> <td>bar KPa 3 300</td> <td>∅</td> <td rowspan="3"> <table border="1"> <tr> <td>⊗</td> <td>Rubinetto di intercettazione Isolator valve Robinet de barrage Absperrhahn</td> </tr> </table> </td> </tr> <tr> <td>1</td> <td>Terminal board Plaque à bornes Klemmenbrett</td> <td>V</td> <td> <table border="1"> <tr> <td>○</td> <td>Ingresso acqua fredda cold water inlet Entrée eau froide kaltwassereintritt</td> <td>bar KPa</td> <td>∅</td> </tr> <tr> <td></td> <td></td> <td></td> <td>L/h</td> </tr> </table> </td> <td rowspan="2"> <table border="1"> <tr> <td>⊗</td> <td>Interruttore magnetotermico differenziale Differential magnetothermic switch Interrupteur magnétothermique différentiel Magnetothermischer differentialschalter</td> </tr> </table> </td> </tr> <tr> <td></td> <td></td> <td></td> <td>L/h</td> </tr> </table>	●	Ingresso acqua calda Hot water inlet Entrée eau chaude Warmwassereintritt	bar KPa 3 300	∅	<table border="1"> <tr> <td>⊗</td> <td>Rubinetto di intercettazione Isolator valve Robinet de barrage Absperrhahn</td> </tr> </table>	⊗	Rubinetto di intercettazione Isolator valve Robinet de barrage Absperrhahn	1	Terminal board Plaque à bornes Klemmenbrett	V	<table border="1"> <tr> <td>○</td> <td>Ingresso acqua fredda cold water inlet Entrée eau froide kaltwassereintritt</td> <td>bar KPa</td> <td>∅</td> </tr> <tr> <td></td> <td></td> <td></td> <td>L/h</td> </tr> </table>	○	Ingresso acqua fredda cold water inlet Entrée eau froide kaltwassereintritt	bar KPa	∅				L/h	<table border="1"> <tr> <td>⊗</td> <td>Interruttore magnetotermico differenziale Differential magnetothermic switch Interrupteur magnétothermique différentiel Magnetothermischer differentialschalter</td> </tr> </table>	⊗	Interruttore magnetotermico differenziale Differential magnetothermic switch Interrupteur magnétothermique différentiel Magnetothermischer differentialschalter				L/h	<table border="1"> <tr> <td>⊗</td> <td>Scarico acqua Water drain</td> <td>Vidange eau WasserAbflub</td> <td>∅</td> <td></td> </tr> </table>	⊗	Scarico acqua Water drain	Vidange eau WasserAbflub	∅	
3	Terminal board Plaque à bornes Klemmenbrett	V	<table border="1"> <tr> <td>●</td> <td>Ingresso acqua calda Hot water inlet Entrée eau chaude Warmwassereintritt</td> <td>bar KPa 3 300</td> <td>∅</td> <td rowspan="3"> <table border="1"> <tr> <td>⊗</td> <td>Rubinetto di intercettazione Isolator valve Robinet de barrage Absperrhahn</td> </tr> </table> </td> </tr> <tr> <td>1</td> <td>Terminal board Plaque à bornes Klemmenbrett</td> <td>V</td> <td> <table border="1"> <tr> <td>○</td> <td>Ingresso acqua fredda cold water inlet Entrée eau froide kaltwassereintritt</td> <td>bar KPa</td> <td>∅</td> </tr> <tr> <td></td> <td></td> <td></td> <td>L/h</td> </tr> </table> </td> <td rowspan="2"> <table border="1"> <tr> <td>⊗</td> <td>Interruttore magnetotermico differenziale Differential magnetothermic switch Interrupteur magnétothermique différentiel Magnetothermischer differentialschalter</td> </tr> </table> </td> </tr> <tr> <td></td> <td></td> <td></td> <td>L/h</td> </tr> </table>	●	Ingresso acqua calda Hot water inlet Entrée eau chaude Warmwassereintritt	bar KPa 3 300	∅	<table border="1"> <tr> <td>⊗</td> <td>Rubinetto di intercettazione Isolator valve Robinet de barrage Absperrhahn</td> </tr> </table>		⊗	Rubinetto di intercettazione Isolator valve Robinet de barrage Absperrhahn	1	Terminal board Plaque à bornes Klemmenbrett	V	<table border="1"> <tr> <td>○</td> <td>Ingresso acqua fredda cold water inlet Entrée eau froide kaltwassereintritt</td> <td>bar KPa</td> <td>∅</td> </tr> <tr> <td></td> <td></td> <td></td> <td>L/h</td> </tr> </table>	○	Ingresso acqua fredda cold water inlet Entrée eau froide kaltwassereintritt	bar KPa	∅				L/h		<table border="1"> <tr> <td>⊗</td> <td>Interruttore magnetotermico differenziale Differential magnetothermic switch Interrupteur magnétothermique différentiel Magnetothermischer differentialschalter</td> </tr> </table>	⊗	Interruttore magnetotermico differenziale Differential magnetothermic switch Interrupteur magnétothermique différentiel Magnetothermischer differentialschalter				L/h	<table border="1"> <tr> <td>⊗</td> <td>Scarico acqua Water drain</td> <td>Vidange eau WasserAbflub</td> <td>∅</td> <td></td> </tr> </table>	⊗	Scarico acqua Water drain	Vidange eau WasserAbflub	∅
●	Ingresso acqua calda Hot water inlet Entrée eau chaude Warmwassereintritt	bar KPa 3 300	∅	<table border="1"> <tr> <td>⊗</td> <td>Rubinetto di intercettazione Isolator valve Robinet de barrage Absperrhahn</td> </tr> </table>	⊗	Rubinetto di intercettazione Isolator valve Robinet de barrage Absperrhahn																														
⊗	Rubinetto di intercettazione Isolator valve Robinet de barrage Absperrhahn																																			
1	Terminal board Plaque à bornes Klemmenbrett	V	<table border="1"> <tr> <td>○</td> <td>Ingresso acqua fredda cold water inlet Entrée eau froide kaltwassereintritt</td> <td>bar KPa</td> <td>∅</td> </tr> <tr> <td></td> <td></td> <td></td> <td>L/h</td> </tr> </table>		○	Ingresso acqua fredda cold water inlet Entrée eau froide kaltwassereintritt	bar KPa	∅				L/h	<table border="1"> <tr> <td>⊗</td> <td>Interruttore magnetotermico differenziale Differential magnetothermic switch Interrupteur magnétothermique différentiel Magnetothermischer differentialschalter</td> </tr> </table>	⊗	Interruttore magnetotermico differenziale Differential magnetothermic switch Interrupteur magnétothermique différentiel Magnetothermischer differentialschalter																					
○	Ingresso acqua fredda cold water inlet Entrée eau froide kaltwassereintritt	bar KPa	∅																																	
			L/h																																	
⊗	Interruttore magnetotermico differenziale Differential magnetothermic switch Interrupteur magnétothermique différentiel Magnetothermischer differentialschalter																																			
			L/h																																	
⊗	Scarico acqua Water drain	Vidange eau WasserAbflub	∅																																	

Mod. CW350S – CW350SD

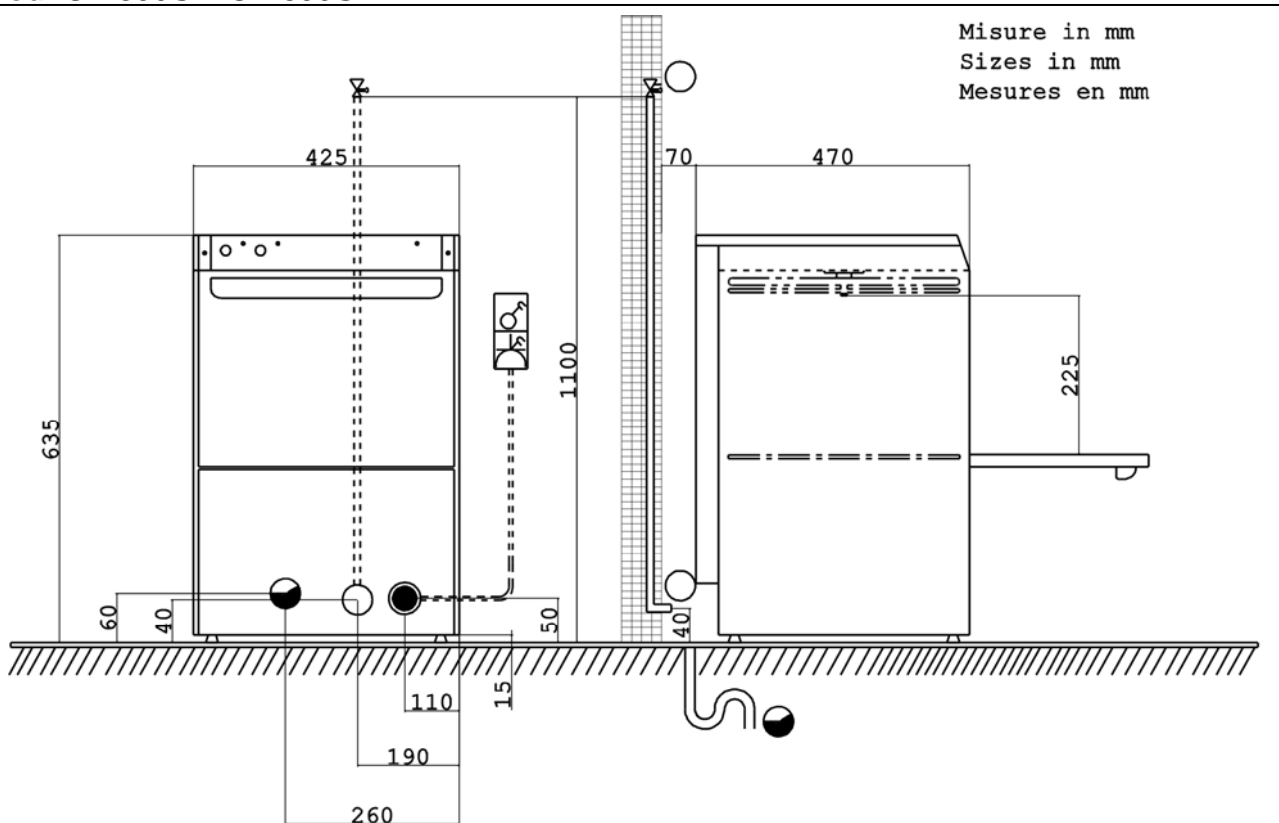

Misure in mm
 Sizes in mm
 Mesures en mm

MODELLO	MODEL	MODELE	kW
CW 350 SD			2.9

● Allacciamento elettrico - Electrical connection Branchement électrique - Elektroanschluss		⊕ Morsetto equipotenziale - Equipotential terminal Borne équipotentiel - Potentilausgleichklemme		NON IN DOTAZIONE NOT INCLUDED PAS EN DOTATION NICHT DABEI																																										
<table border="1"> <tr> <td>3</td> <td>☑</td> </tr> </table> Morsettiera Terminal board Plaque à bornes Klemmenbrett	3	☑	V Hz A	<table border="1"> <tr> <td>●</td> <td>Ingresso acqua calda Hot water inlet Entrée eau chaude Wamwassereintritt</td> <td> <table border="1"> <tr> <td>bar</td> <td>∅</td> </tr> <tr> <td>KPa</td> <td>L/h</td> </tr> <tr> <td>3</td> <td></td> </tr> <tr> <td>300</td> <td></td> </tr> </table> </td> <td> Rubinetto di intercettazione Isolator valve Robinet de barrage Absperrhahn </td> </tr> <tr> <td> <table border="1"> <tr> <td>1</td> <td>☑</td> </tr> </table> Morsettiera Terminal board Plaque à bornes Klemmenbrett </td> <td> V Hz A </td> <td> <table border="1"> <tr> <td>○</td> <td>Ingresso acqua fredda cold water inlet Entrée eau froide kaltwassereintritt</td> <td> <table border="1"> <tr> <td>bar</td> <td>∅</td> </tr> <tr> <td>KPa</td> <td>L/h</td> </tr> <tr> <td>3</td> <td></td> </tr> <tr> <td>300</td> <td></td> </tr> </table> </td> <td> <table border="1"> <tr> <td>⊗</td> <td>Interruttore magnetotermico differenziale Differential magnetothermic switch Interrupteur magnétothermique différentiel Magnetothermischer differentialschalter</td> </tr> </table> </td> </tr> <tr> <td> <table border="1"> <tr> <td>~</td> <td>●</td> </tr> </table> Cavo elettrico Electrical cable Câble électrique Elektrokabel </td> <td> V Hz mm² </td> <td> <table border="1"> <tr> <td>●</td> <td>Scarico acqua Water drain</td> <td> <table border="1"> <tr> <td>Vidange eau WasserAbflub</td> <td>∅</td> </tr> </table> </td> <td></td> </tr> </table> </td> </tr> </table></td></tr></table>	●	Ingresso acqua calda Hot water inlet Entrée eau chaude Wamwassereintritt	<table border="1"> <tr> <td>bar</td> <td>∅</td> </tr> <tr> <td>KPa</td> <td>L/h</td> </tr> <tr> <td>3</td> <td></td> </tr> <tr> <td>300</td> <td></td> </tr> </table>	bar	∅	KPa	L/h	3		300		Rubinetto di intercettazione Isolator valve Robinet de barrage Absperrhahn	<table border="1"> <tr> <td>1</td> <td>☑</td> </tr> </table> Morsettiera Terminal board Plaque à bornes Klemmenbrett	1	☑	V Hz A	<table border="1"> <tr> <td>○</td> <td>Ingresso acqua fredda cold water inlet Entrée eau froide kaltwassereintritt</td> <td> <table border="1"> <tr> <td>bar</td> <td>∅</td> </tr> <tr> <td>KPa</td> <td>L/h</td> </tr> <tr> <td>3</td> <td></td> </tr> <tr> <td>300</td> <td></td> </tr> </table> </td> <td> <table border="1"> <tr> <td>⊗</td> <td>Interruttore magnetotermico differenziale Differential magnetothermic switch Interrupteur magnétothermique différentiel Magnetothermischer differentialschalter</td> </tr> </table> </td> </tr> <tr> <td> <table border="1"> <tr> <td>~</td> <td>●</td> </tr> </table> Cavo elettrico Electrical cable Câble électrique Elektrokabel </td> <td> V Hz mm² </td> <td> <table border="1"> <tr> <td>●</td> <td>Scarico acqua Water drain</td> <td> <table border="1"> <tr> <td>Vidange eau WasserAbflub</td> <td>∅</td> </tr> </table> </td> <td></td> </tr> </table> </td> </tr> </table>	○	Ingresso acqua fredda cold water inlet Entrée eau froide kaltwassereintritt	<table border="1"> <tr> <td>bar</td> <td>∅</td> </tr> <tr> <td>KPa</td> <td>L/h</td> </tr> <tr> <td>3</td> <td></td> </tr> <tr> <td>300</td> <td></td> </tr> </table>	bar	∅	KPa	L/h	3		300		<table border="1"> <tr> <td>⊗</td> <td>Interruttore magnetotermico differenziale Differential magnetothermic switch Interrupteur magnétothermique différentiel Magnetothermischer differentialschalter</td> </tr> </table>	⊗	Interruttore magnetotermico differenziale Differential magnetothermic switch Interrupteur magnétothermique différentiel Magnetothermischer differentialschalter	<table border="1"> <tr> <td>~</td> <td>●</td> </tr> </table> Cavo elettrico Electrical cable Câble électrique Elektrokabel	~	●	V Hz mm ²	<table border="1"> <tr> <td>●</td> <td>Scarico acqua Water drain</td> <td> <table border="1"> <tr> <td>Vidange eau WasserAbflub</td> <td>∅</td> </tr> </table> </td> <td></td> </tr> </table>	●	Scarico acqua Water drain	<table border="1"> <tr> <td>Vidange eau WasserAbflub</td> <td>∅</td> </tr> </table>	Vidange eau WasserAbflub	∅	
3	☑																																													
●	Ingresso acqua calda Hot water inlet Entrée eau chaude Wamwassereintritt	<table border="1"> <tr> <td>bar</td> <td>∅</td> </tr> <tr> <td>KPa</td> <td>L/h</td> </tr> <tr> <td>3</td> <td></td> </tr> <tr> <td>300</td> <td></td> </tr> </table>	bar	∅	KPa	L/h	3		300		Rubinetto di intercettazione Isolator valve Robinet de barrage Absperrhahn																																			
bar	∅																																													
KPa	L/h																																													
3																																														
300																																														
<table border="1"> <tr> <td>1</td> <td>☑</td> </tr> </table> Morsettiera Terminal board Plaque à bornes Klemmenbrett	1	☑	V Hz A	<table border="1"> <tr> <td>○</td> <td>Ingresso acqua fredda cold water inlet Entrée eau froide kaltwassereintritt</td> <td> <table border="1"> <tr> <td>bar</td> <td>∅</td> </tr> <tr> <td>KPa</td> <td>L/h</td> </tr> <tr> <td>3</td> <td></td> </tr> <tr> <td>300</td> <td></td> </tr> </table> </td> <td> <table border="1"> <tr> <td>⊗</td> <td>Interruttore magnetotermico differenziale Differential magnetothermic switch Interrupteur magnétothermique différentiel Magnetothermischer differentialschalter</td> </tr> </table> </td> </tr> <tr> <td> <table border="1"> <tr> <td>~</td> <td>●</td> </tr> </table> Cavo elettrico Electrical cable Câble électrique Elektrokabel </td> <td> V Hz mm² </td> <td> <table border="1"> <tr> <td>●</td> <td>Scarico acqua Water drain</td> <td> <table border="1"> <tr> <td>Vidange eau WasserAbflub</td> <td>∅</td> </tr> </table> </td> <td></td> </tr> </table> </td> </tr> </table>	○	Ingresso acqua fredda cold water inlet Entrée eau froide kaltwassereintritt	<table border="1"> <tr> <td>bar</td> <td>∅</td> </tr> <tr> <td>KPa</td> <td>L/h</td> </tr> <tr> <td>3</td> <td></td> </tr> <tr> <td>300</td> <td></td> </tr> </table>	bar	∅	KPa	L/h	3		300		<table border="1"> <tr> <td>⊗</td> <td>Interruttore magnetotermico differenziale Differential magnetothermic switch Interrupteur magnétothermique différentiel Magnetothermischer differentialschalter</td> </tr> </table>	⊗	Interruttore magnetotermico differenziale Differential magnetothermic switch Interrupteur magnétothermique différentiel Magnetothermischer differentialschalter	<table border="1"> <tr> <td>~</td> <td>●</td> </tr> </table> Cavo elettrico Electrical cable Câble électrique Elektrokabel	~	●	V Hz mm ²	<table border="1"> <tr> <td>●</td> <td>Scarico acqua Water drain</td> <td> <table border="1"> <tr> <td>Vidange eau WasserAbflub</td> <td>∅</td> </tr> </table> </td> <td></td> </tr> </table>	●	Scarico acqua Water drain	<table border="1"> <tr> <td>Vidange eau WasserAbflub</td> <td>∅</td> </tr> </table>	Vidange eau WasserAbflub	∅																		
1	☑																																													
○	Ingresso acqua fredda cold water inlet Entrée eau froide kaltwassereintritt	<table border="1"> <tr> <td>bar</td> <td>∅</td> </tr> <tr> <td>KPa</td> <td>L/h</td> </tr> <tr> <td>3</td> <td></td> </tr> <tr> <td>300</td> <td></td> </tr> </table>	bar	∅	KPa	L/h	3		300		<table border="1"> <tr> <td>⊗</td> <td>Interruttore magnetotermico differenziale Differential magnetothermic switch Interrupteur magnétothermique différentiel Magnetothermischer differentialschalter</td> </tr> </table>	⊗	Interruttore magnetotermico differenziale Differential magnetothermic switch Interrupteur magnétothermique différentiel Magnetothermischer differentialschalter																																	
bar	∅																																													
KPa	L/h																																													
3																																														
300																																														
⊗	Interruttore magnetotermico differenziale Differential magnetothermic switch Interrupteur magnétothermique différentiel Magnetothermischer differentialschalter																																													
<table border="1"> <tr> <td>~</td> <td>●</td> </tr> </table> Cavo elettrico Electrical cable Câble électrique Elektrokabel	~	●	V Hz mm ²	<table border="1"> <tr> <td>●</td> <td>Scarico acqua Water drain</td> <td> <table border="1"> <tr> <td>Vidange eau WasserAbflub</td> <td>∅</td> </tr> </table> </td> <td></td> </tr> </table>	●	Scarico acqua Water drain	<table border="1"> <tr> <td>Vidange eau WasserAbflub</td> <td>∅</td> </tr> </table>	Vidange eau WasserAbflub	∅																																					
~	●																																													
●	Scarico acqua Water drain	<table border="1"> <tr> <td>Vidange eau WasserAbflub</td> <td>∅</td> </tr> </table>	Vidange eau WasserAbflub	∅																																										
Vidange eau WasserAbflub	∅																																													

Mod. CW400B

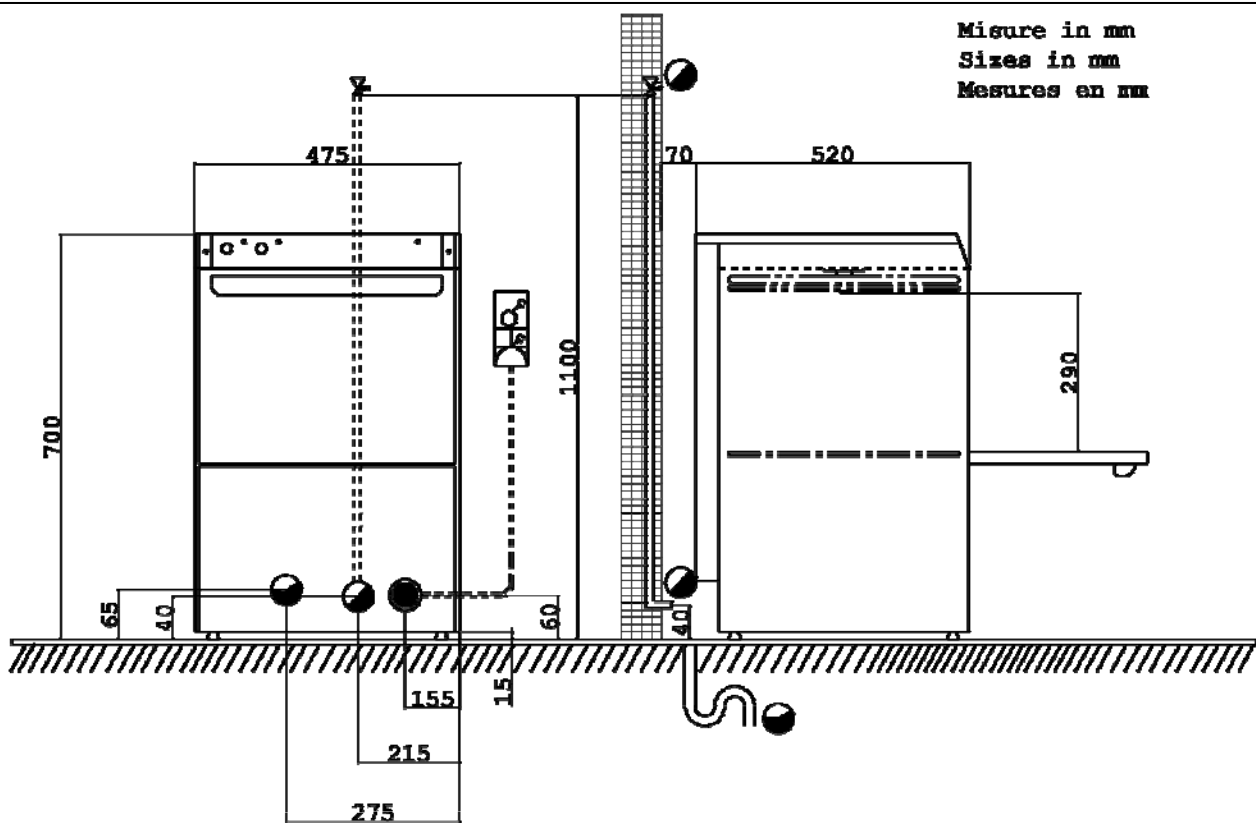

MODELLO	MODEL	MODELE	kW
CW 400B			2.9

● Allacciamento elettrico - Electrical connection Branchement électrique - Elektroanschluss		⊕ Morsetto equipotenziale - Equipotential terminal Rene équipotentiale - Potentiaal aansluiting		NON IN DOTAZIONE NOT INCLUDED NIEZ W DOTACIJI NICHT BESLIT																											
<table border="1"> <tr> <td>3</td> <td><input checked="" type="checkbox"/></td> </tr> </table>	3	<input checked="" type="checkbox"/>	<table border="1"> <tr> <td>V</td> <td></td> </tr> <tr> <td>Hz</td> <td></td> </tr> <tr> <td>A</td> <td></td> </tr> </table>	V		Hz		A		<table border="1"> <tr> <td>Ingresso acqua calda</td> <td>lit/min</td> <td>mm</td> </tr> <tr> <td>Hot water inlet</td> <td>l/h</td> <td>mm</td> </tr> <tr> <td>Entrée eau chaude</td> <td>l/h</td> <td>mm</td> </tr> <tr> <td>Wassereintritt</td> <td>l/h</td> <td>mm</td> </tr> </table>	Ingresso acqua calda	lit/min	mm	Hot water inlet	l/h	mm	Entrée eau chaude	l/h	mm	Wassereintritt	l/h	mm	<table border="1"> <tr> <td>Valvola di intercettazione</td> <td></td> </tr> <tr> <td>Isolator valve</td> <td></td> </tr> <tr> <td>Robinet de barrage</td> <td></td> </tr> <tr> <td>Absperrbahn</td> <td></td> </tr> </table>	Valvola di intercettazione		Isolator valve		Robinet de barrage		Absperrbahn	
3	<input checked="" type="checkbox"/>																														
V																															
Hz																															
A																															
Ingresso acqua calda	lit/min	mm																													
Hot water inlet	l/h	mm																													
Entrée eau chaude	l/h	mm																													
Wassereintritt	l/h	mm																													
Valvola di intercettazione																															
Isolator valve																															
Robinet de barrage																															
Absperrbahn																															
<table border="1"> <tr> <td>1</td> <td><input checked="" type="checkbox"/></td> </tr> </table>	1	<input checked="" type="checkbox"/>	<table border="1"> <tr> <td>V</td> <td></td> </tr> <tr> <td>Hz</td> <td></td> </tr> <tr> <td>A</td> <td></td> </tr> </table>	V		Hz		A		<table border="1"> <tr> <td>Ingresso acqua fredda</td> <td>lit/min</td> <td>mm</td> </tr> <tr> <td>cold water inlet</td> <td>l/h</td> <td>mm</td> </tr> <tr> <td>Entrée eau froide</td> <td>l/h</td> <td>mm</td> </tr> <tr> <td>Kaltwasserantritt</td> <td>l/h</td> <td>mm</td> </tr> </table>	Ingresso acqua fredda	lit/min	mm	cold water inlet	l/h	mm	Entrée eau froide	l/h	mm	Kaltwasserantritt	l/h	mm	<table border="1"> <tr> <td>Interruttore magnetotermico differenziale</td> <td></td> </tr> <tr> <td>differential magnetothermal switch</td> <td></td> </tr> <tr> <td>Interrupteur magnétothermique différentiel</td> <td></td> </tr> <tr> <td>Magnetothermischer Differenzialschalter</td> <td></td> </tr> </table>	Interruttore magnetotermico differenziale		differential magnetothermal switch		Interrupteur magnétothermique différentiel		Magnetothermischer Differenzialschalter	
1	<input checked="" type="checkbox"/>																														
V																															
Hz																															
A																															
Ingresso acqua fredda	lit/min	mm																													
cold water inlet	l/h	mm																													
Entrée eau froide	l/h	mm																													
Kaltwasserantritt	l/h	mm																													
Interruttore magnetotermico differenziale																															
differential magnetothermal switch																															
Interrupteur magnétothermique différentiel																															
Magnetothermischer Differenzialschalter																															
<table border="1"> <tr> <td>~</td> <td></td> </tr> </table>	~		<table border="1"> <tr> <td>V</td> <td></td> </tr> <tr> <td>Hz</td> <td></td> </tr> <tr> <td>mm²</td> <td></td> </tr> </table>	V		Hz		mm ²		<table border="1"> <tr> <td>Scarico acqua</td> <td>mm</td> </tr> <tr> <td>Vidange eau</td> <td>mm</td> </tr> <tr> <td>Water drain</td> <td>mm</td> </tr> <tr> <td>Wasserabfluß</td> <td>mm</td> </tr> </table>	Scarico acqua	mm	Vidange eau	mm	Water drain	mm	Wasserabfluß	mm													
~																															
V																															
Hz																															
mm ²																															
Scarico acqua	mm																														
Vidange eau	mm																														
Water drain	mm																														
Wasserabfluß	mm																														

Mod. CW400BS - CW400BSD

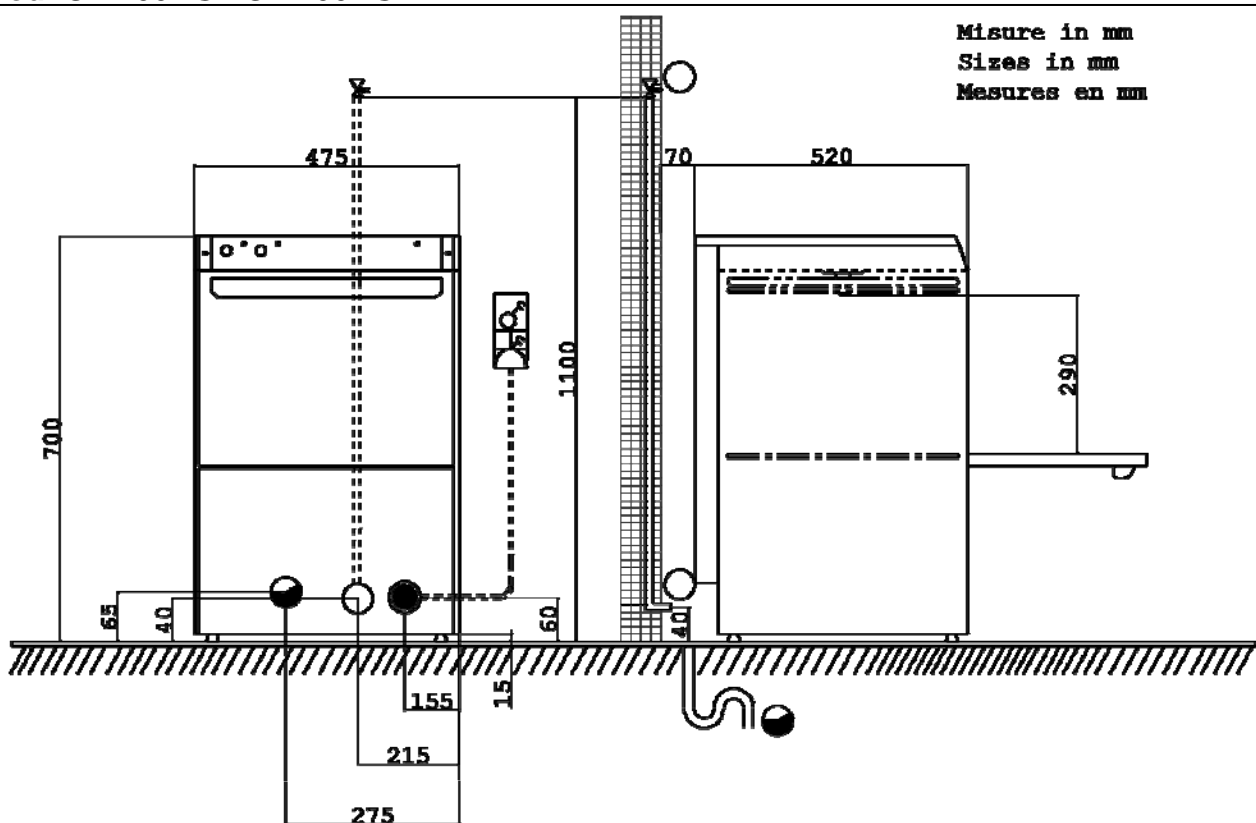

Misure in mm
 Sizes in mm
 Mesures en mm

MODELLO	MODEL	MODELE	kW
CW 400B SD			2.9

● Allacciamento elettrico - Electrical connection Branchement électrique - Elektroanschluss		⊕ Morsetto isopotenziale - Isopotential terminal Sema èquipotential - Potentiaal aansluitklemme		NON IN DOTAZIONE NOT INCLUDED PAS EN DOTATION NICHT DEBIET	
3 <input checked="" type="checkbox"/> Morsettiera Terminal board Plaque à bornes Klemmenbrett	V Hz A	⊕ Ingresso acqua calda Hot water inlet Entrée eau chaude Warmwasserz Eintritt	1/2" 3/4" 1" 3/2"	g L/h	⊕ Rubinetto di intercettazione Isolator valve Robinet de barrage Absperrhahn
1 <input checked="" type="checkbox"/> Morsettiera Terminal board Plaque à bornes Klemmenbrett	V Hz A	○ Ingresso acqua fredda cold water inlet Entrée eau froide Kaltwasserz Eintritt	1/2" 3/4" 1" 3/2"	g L/h	⊕ Interruttore magnetotermico differenziale differential magnetothermal switch Interrupteur magnétothermique différentiel Magnetothermischer differenzialschalter
~ Cavo elettrico Electrical cable Câble électrique Elektrokabel	V Hz mm ²	● Scarico acqua Water drain Wasserabfluß	g		

Mod CW400R

Misure in mm
 Sizes in mm
 Mesures en mm

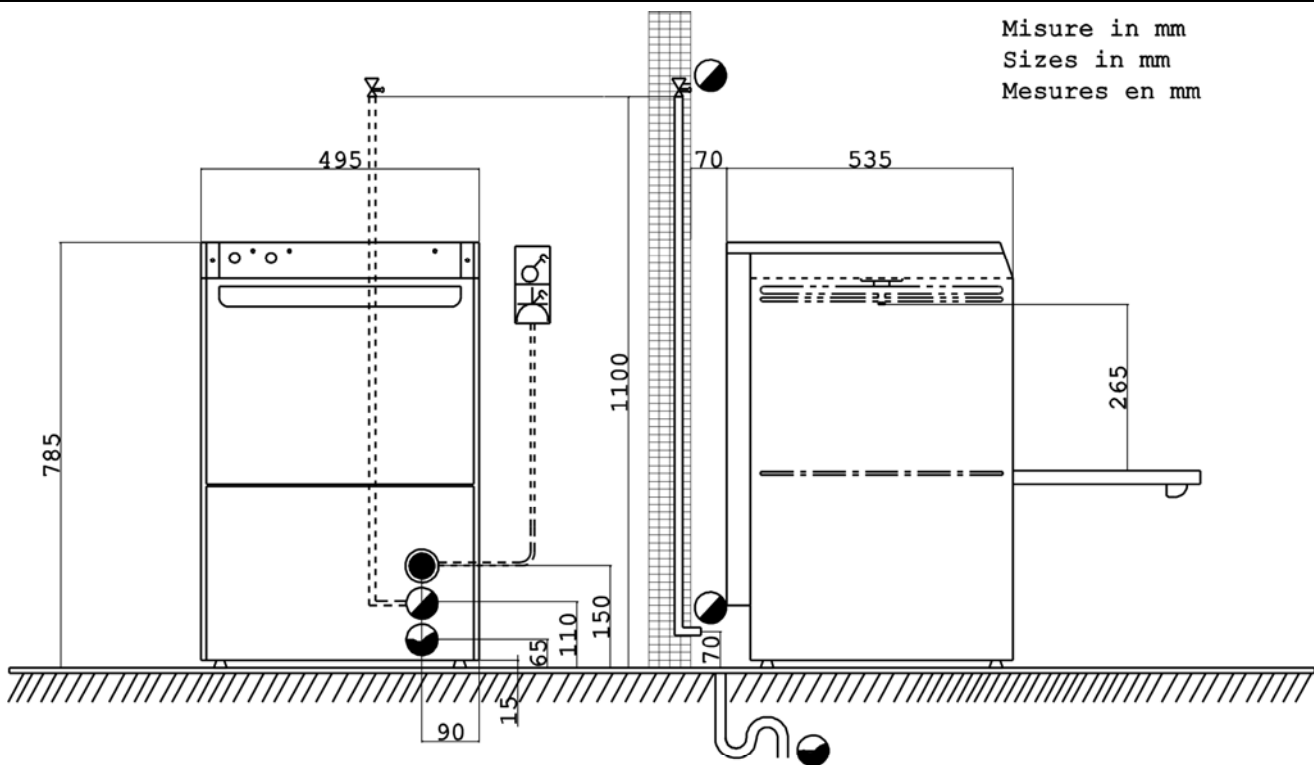

MODELLO	MODEL	MODELE	kW
	CW 400 R		4.8

Allacciamento elettrico - Electrical connection Branchement électrique - Elektroanschluss		Morsetto equipotenziale - Equipotential terminal Borne équipotential - Potentillaausgleichklemme		NON IN DOTAZIONE NOT INCLUDED PAS EN DOTATION NICHT DABEI		
Morsettiera Terminal board Plaque à bornes Klemmenbrett	V	Ingresso acqua calda Hot water inlet Entrée eau chaude Warmwassereintritt	bar	Rubinetto di intercettazione Isolator valve Robinet de barrage Absperrhahn	3 L/h	
	Hz		Ingresso acqua fredda cold water inlet Entrée eau froide kaltwassereintritt			bar kPa
	A		3 300			
Morsettiera Terminal board Plaque à bornes Klemmenbrett	V	Scarico acqua Vidange eau Water drain WasserAbflub	bar kPa	Interruttore magnetotermico differenziale Differential magnetothermic switch Interrupteur magnétothermique différentiel Magnetothermischer differentialschalter	3 L/h	
	Hz					
	A					
Cavo elettrico Electrical cable Câble électrique Elektrokabel	V					
	Hz					
	mm ²					

